

Chemicals in European waters

Knowledge developments

ISSN 1977-8449



Chemicals in European waters

Knowledge developments



Cover design: EEA
Cover photo: © Andrew Curtis

Acknowledgements

EEA lead author

Caroline Whalley.

European Topic Centre on Inland, Coastal and Marine Waters authors and contributors

Lead author: Volker Mohaupt (Umweltbundesamt).

Wibke Busch (UFZ), Joost van den Roovaart and Nanette van Duijnhoven (Deltares), Ingo Kirst and Ursula Schmedtje (Umweltbundesamt), Rolf Altenburger (UFZ) and Linda Sommer (Umweltbundesamt).

The authors are grateful for the contributions and advice from:

EEA staff: Peter Kristensen, Fernanda Néry, Ronan Uhel, Bastian Zeiger, Stéphane Isoard and Catherine Ganzleben.

Member States and countries: European Environment Information and Observation Network (Eionet), National Reference Centres for Freshwater and Emissions, Water Framework Directive Working Group on Chemicals. In particular: Asa Andersson, Malgorzata Bednarek, Emmanuelle Gratia, Simon Hatfield, Therese Leonhardt Hjorth, Andrea Majovska, Maria Szomolanyi Ritvayne, Marloes Schiereck and Kimmo Silvo.

Other stakeholders: Eureau and Eurometaux.

Legal notice

The contents of this publication do not necessarily reflect the official opinions of the European Commission or other institutions of the European Union. Neither the European Environment Agency nor any person or company acting on behalf of the Agency is responsible for the use that may be made of the information contained in this report.

Copyright notice

© European Environment Agency, 2018
Reproduction is authorised provided the source is acknowledged.

More information on the European Union is available on the Internet (<http://europa.eu>).

Luxembourg: Publications Office of the European Union, 2018

ISBN 978-92-9480-006-0
ISSN 1977-8449
doi:10.2800/265080

European Environment Agency
Kongens Nytorv 6
1050 Copenhagen K
Denmark

Tel.: +45 33 36 71 00
Web: eea.europa.eu
Enquiries: eea.europa.eu/enquiries

Contents

Executive summary	5
1 Introduction	6
1.1 Aim of this report	6
1.2 Structure of the report	6
1.3 Context	6
1.4 EU policy context for chemicals in surface waters	8
2 'Known unknowns' — unregulated micropollutants and chemical mixtures	11
2.1 Introduction	11
2.2 Chemical status and ecological status/potential assessment	12
2.3 Evidence for chemical pollution causing ecological effects	15
2.4 Mixtures of chemicals.....	17
2.5 Examples combining chemical and biological monitoring.....	20
2.6 Towards monitoring and assessment of chemical mixtures.....	21
2.7 Challenges.....	24
2.8 Summary	24
3 Known risks: key pollutants and their sources	25
3.1 Introduction	25
3.2 Chemical status, RBSPs and pollutants most frequently exceeding standards in Europe.....	25
3.3 Emission sources and pathways	28
3.4 Contamination through atmospheric deposition	30
3.5 Contamination from urban settlements	35
3.6 Contamination from metals and cyanide — mining and use.....	39
3.7 Contamination from agriculture	42
3.8 Contamination from navigation	47
3.9 Summary	49

4 Strategies to reduce the chemical pollution of water	51
4.1 Introduction	51
4.2 EU strategic approach to pharmaceuticals in the environment.....	52
4.3 National Action Plans to reduce the risks posed by pesticides	54
4.4 National action programmes for combating risks posed by micropollutants.....	54
4.5 Summary	55
5 Conclusions	56
5.1 Introduction	56
5.2 Conclusions on assessing the ecological impacts of chemical pollution.....	56
5.3 Data collection on chemicals in water at the EU level	57
5.4 Conclusions on the effectiveness of source control legislation	60
List of abbreviations.....	63
References	65
Annex 1 Derivation of emissions data for the figures in Chapter 2.....	72

Executive summary

European Union (EU) and international policies have been tackling water and environmental pollution for nearly 50 years. Gross chemical pollution, exemplified by 'dead rivers', has been successfully addressed in many cases. However, in its recent report *European waters — Assessment of status and pressures 2018*, which was based on data from Member States on the implementation of the Water Framework Directive (2000/60/EC) (WFD), the European Environment Agency (EEA) found that only 38 % of EU surface water bodies are in good chemical status. 46 % are failing to achieve good chemical status and 16 % are in unknown chemical status (EEA, 2018a).

Chemical status of surface waters under the WFD is assessed against a relatively short list of historically important pollutants. The concentration of a substance in the water is compared with an environmental quality standard (EQS) set for a single substance. This approach has been used for many years and fits well with regulations seeking to control chemicals at source.

Most failures in the chemical status of surface waters can be attributed to three groups of substances, all of which are persistent and widely distributed: mercury and its compounds, PAHs (polycyclic aromatic hydrocarbons) and pBDEs (polybrominated diphenylethers). Through an analysis of the monitoring and emissions data reported by countries, specific actions can be determined that target these priority substances. Action should be taken to reduce all emissions of these substances, in particular, atmospheric emissions. We need to improve understanding of the pathways taken by pBDEs and the pressures causing PAHs to pollute surface waters.

Monitoring under the WFD provides important feedback on the effectiveness of chemical source control. However, our understanding of the complex interactions between chemicals and living organisms has greatly increased over the last 20 years. At concentrations lower than those that kill directly, harmful chemicals may exert more subtle effects on

organisms, for example by limiting the organism's ability to reproduce. Concern has been raised about the 'cocktail effect', whereby mixtures of substances that may individually be present at harmless concentrations may combine in complicated ways to affect health. New approaches have been developed to measure these effects in effluents and the environment, and these offer ways to assess the potential risks presented by mixtures while still providing information on the types of chemicals causing these risks. This causal information is important for the implementation of effective measures against pollution.

From the reported data, we can see that for a number of priority substances, measures seem to have been effective in preventing the entry of these chemicals into surface waters. This success should be welcomed and we should learn the lessons around which approaches work and which do not. However, there are many more chemicals in the environment about which we know little. The challenge presented by chemical mixtures highlights the need to fundamentally review which chemicals we use and how we use them. For the longer term, moving to a less toxic, safer and more sustainable future requires the development of approaches that avoid the use of hazardous substances.

Emissions data on pollutants as reported in Europe (for the WFD, the European Pollutant Release and Transfer Register (E-PRTR) or the reporting of the Water Information System for Europe — State of the Environment (WISE-SoE)) can give an important overview on emissions, the impact of measures and trends. However, such data are incomplete and inconsistent and too often exclude diffuse sources. Improvements to our understanding of emissions could be achieved by streamlining of emissions reporting requirements, towards securing robust data satisfying all European emissions to water reporting requirements, and improving the monitoring, modelling and reporting of diffuse sources, to ensure that pressures are correctly understood and measures can be appropriately targeted.

1 Introduction

1.1 Aim of this report

Like water, chemicals are an essential part of our daily lives. However, some chemicals present risks to plants and animals living in water, as well as to the animals eating them. The risks presented by some chemicals have been recognised for decades, but new risks presented by other chemicals, either alone or in combination, are continually being identified. Understanding which chemicals continue to pose significant risks in or via water, and why, can help to improve controls for minimising harm.

Techniques are now available that provide integrated measures of toxicity or harm, contrasting with more traditional methods, which measured individual substances. Understanding the relationship between a substance and its source is fundamental to the chemical regulation system, yet this can be difficult, as there are thousands of chemicals in daily use. Effect-based methods, which provide an integrated measure of the 'chemical health' of the aquatic environment, could therefore offer a link between the ecological and chemical status of surface water bodies under the Water Framework Directive (2000/60/EC) (WFD) (EU, 2000).

Monitoring and modelling of pollutants are used in the assessment of water quality. Knowledge about the amount of substances released into the environment over time can be used to assess emission trends. Together, the data for water quality and emissions can be used to inform upon whether or not control measures are leading to the reduction of pollution.

Describing some of the newer techniques and reviewing information about key pollutants under the WFD, this report gives both an overview of what is known and a view of how surface waters could be better protected in the future.

1.2 Structure of the report

Chapter 1 sets out the structure of this report and the legal background at European and international levels. Our knowledge of how chemicals can cause

harm to organisms in water has significantly improved over recent years, and an overview of the current knowledge is provided in Chapter 2. In particular, Chapter 2 deals with sublethal effects (such as problems with reproduction) and mixtures of chemicals that, in combination, may act to harm sensitive species. Application of the precautionary principle would require that this knowledge be used in risk assessment to protect both the aquatic environment and human health. Chapter 3 goes on to consider what we actually know from the data reported at the European level, and places these data in the context of reporting under the WFD. It reviews what we know about the pressures still causing surface water bodies to fail to achieve good chemical status, including information from European emissions reporting. Chapter 4 considers approaches to tackling chemical pollution, looking at some European Union (EU) and national strategies and plans. The final chapter draws conclusions on what more needs to be done to protect surface waters from chemical pollution.

The scope of this report is hazardous substances, such as those with toxic, persistent and bioaccumulative properties, not those that act as nutrients. The focus is on substances reported at the European level, rather than emerging pollutants.

1.3 Context

Action has been taken over several decades to address the chemical pollution of water in Europe. The precautionary principle, enshrined in the Treaty of the Functioning of the European Union, underpins the approach to policymaking when an environmental or human health hazard is uncertain and the stakes are high (EPRS, 2015). Initial efforts to reduce gross industrial pollution of rivers and seas was followed by European legislation to limit sewage pollution. Scientific and public understanding of water pollution issues has increased and reports such as the European Environment Agency (EEA)'s *'Late lessons from early warnings'* served to highlight how information could be used to better protect human health and the environment (EEA, 2001, 2013).



The EU WFD aims to ensure good chemical status of both surface water and groundwater bodies across Europe. For surface waters, this goal is defined by limits on the concentration of certain pollutants relevant across the EU, known as priority substances. Good chemical status means that the concentrations of all of the priority substances and certain other pollutants do not exceed the environmental quality standards (EQSs).

Under the WFD, River Basin Management Plans (RBMPs) include the assessment of the status of and pressures on water bodies. A comparison of the results in the second cycle (EEA, 2018a) with those in the first cycle (EEA, 2012) shows marked improvements in the monitoring and classification of chemical status, with a clear reduction in the number of water bodies in unknown chemical status. The percentage of surface water bodies with good chemical status within the EU is 38 %, while 46 % are not achieving good chemical status and 16 % have unknown chemical status.

In many Member States, only a few substances are responsible for most of the failures of water bodies to achieve good chemical status. Mercury causes failure in a high number of water bodies. Omitting widespread pollution by ubiquitous priority substances including mercury, the proportion of water bodies with a good chemical status improves to 81 %, while only 3 % do not achieve good chemical status and 16 % have unknown chemical status. The main pressures leading to a failure to achieve good chemical status are atmospheric deposition and discharges from urban waste water treatment plants (UWWTPs).

Since the first cycle of reporting of RBMPs (EEA, 2012), Member States have made progress in tackling priority substances, significantly reducing the number of water bodies failing the standards for substances such as several priority metals (cadmium, lead and nickel) and pesticides.

The present report provides a more in-depth assessment of the key pollutants leading to the failures of surface waters to achieve good chemical status in the second cycle of RBMP reporting, including the sources and ecological impacts in the aquatic environment of these pollutants. While surface waters in the WFD also cover transitional and coastal waters, we focus here on rivers and lakes.

In relation to hazardous substances, there has been considerable activity in Europe, starting with the Programme of Action of the European Communities on the Environment in 1973 (EC, 1973). The 1976 Dangerous Substances Directive (76/464/EEC) was implemented by Member States with action programmes on emissions and quality objectives, as well as reporting activities. The WFD (EU, 2000) provided an overarching approach to water management, including European and national prioritisation of pollutants, including the Environmental Quality Standards Directive (2008/105/EC) (EQSD) (EU, 2008a). The EEA contributed publications such as *Hazardous substances in Europe's fresh and marine waters* (EEA, 2011), the *European Waters 2012 report* (EEA, 2012) and technical reports of the European Topic Centre on Inland, Coastal and Marine Waters (ETC-ICM), namely 3/2015 on hazardous substances (ETC-ICM, 2015) and 3/2017 on emissions into Europe's waters (ETC-ICM, 2017).

Box 1.1 When pollution protection breaks down — cyanide

Cyanide is very toxic, inhibiting respiratory processes by irreversible binding to blood cells. It has been used in gold and silver mining, pigments (Prussian blue), biocides and the production of textiles and pharmaceuticals. Natural processes create cyanides in fungi, plants and bacteria. Most cyanides in water originate from industry. Restrictions limit their use in the EU, owing to their high toxicity.

Serious pollution by cyanide occurred after an accident at a gold mine in Romania in 2000. A dam near Baia Mare holding 100 000 m³ of water contaminated with 100 tonnes of cyanide spilled into the Someş River, which flows into the Tisza. The spill is estimated to have killed over 1 200 tonnes of fish (UNEP/OCHA, 2000).

Just as the WFD provides a way to manage water across administrative boundaries, chemicals monitored under the WFD bridge the legislation covering aquatic environment and source control of chemicals. Monitoring evidence collected under the WFD can tell us about the effectiveness of source control legislation for the aquatic environment. This monitoring of chemicals in water addresses a key information need, since most existing legislation for the source control of chemicals involves no monitoring (e.g. the Registration, Evaluation, Authorisation and Restriction of Chemicals (REACH) Regulation and the legislation for biocides). It is also an opportunity to highlight the links along the chain of drivers, pressures, state, impacts and responses (DPSIR) from the chemicals' sources all the way into the aquatic environment and to possibly identify gaps in reporting obligations.

This report draws on additional data sources from other reporting streams, in particular the European Pollutant Release and Transfer Register (E-PRTR) and the Urban Waste Water Treatment Directive (91/271/EEC) (EU, 1991a). It also draws on the reporting of emissions for the Water Information System for Europe — State of the Environment (WISE-SoE). Data for EEA member countries outside the EU have been incorporated where possible.

Monitoring requirements typically address well-known pollutants such as mercury and lead. This means that the availability of data for these substances should be relatively high, while the availability of information on most of the more recently identified pollutants is much lower. Over recent years, scientific concern has risen in relation to the potential effects of mixtures of chemicals on aquatic life. There is particular concern in relation to substances designed to kill, such as pesticides, which may be found together at low concentrations in the same time and place. Advances in chemical analysis, using effect-based methods to assess these combinations, are providing ways to identify risks to the environment.

Recent research linking chemical contamination with ecological effects in the aquatic environment is discussed in Chapter 2, in particular results of the Seventh EU Framework Programme for Research and Technological Development (FP7) project 'Solutions for present and future emerging pollutants in land and water resources management' (SOLUTIONS) (¹). Chapter 2 also considers the research into new methods for chemical assessment, such as non-targeted screening and other integrative monitoring methods.

(¹) <http://www.solutions-project.eu/project> (accessed 14 November 2018).

1.4 EU policy context for chemicals in surface waters

1.4.1 Water Framework Directive

The WFD entered into force on 22nd December 2000, establishing a framework for the protection of inland surface waters, transitional waters, coastal waters and groundwater. Among the objectives of the WFD is the aim of working towards enhanced protection and improvement of the aquatic environment, through specific measures for priority substances. Priority substances are set out in the EQSD (EU, 2008a) and are defined as those substances presenting a significant risk to or via the aquatic environment.

The requirement for surface waters to achieve good chemical status under the WFD means meeting certain standards for ecological and chemical status. 'Good chemical status' means that the concentrations of all priority substances and certain other pollutants in



© Caroline Whalley

a water body are below the EQS, i.e. if a water body fails to meet one EQS, it does not achieve good status. These standards are set at the European level. More local chemical standards, for substances discharged in significant quantities, can be set by Member States as river basin-specific pollutants (RBSPs) and these contribute to the classification of ecological status.

The EQSD (EU, 2008a) defined the EQSs that apply across the EU. Regular review of the EQSD includes review of the list of priority substances (Annex 10 of the WFD). This was first done in 2013, when 12 substances and groups of substances were added to the existing 33 priority substances (EU, 2013a). Among the priority substances of the WFD, some are defined as priority hazardous substances, which should be 'phased out', i.e. all discharges, emissions and losses must be ceased ⁽²⁾.

Article 7 of the WFD is targeted at protecting human health. If the drinking water standard is exceeded at the tap and the water in question was taken from surface waters, specific measures need to be taken for the affected water bodies to ensure compliance with the drinking water standard. This approach updated the drinking water standard for pesticides, which was set in 1980.

1.4.2 Other EU legislation on water protection concerning chemicals

- The Groundwater Directive (2006/118/EC) (EU, 2006b), as a daughter of the WFD, established specific measures to prevent and control groundwater pollution. These measures included criteria for the assessment of good groundwater chemical status and for the identification and reversal of significant and sustained upwards trends. It aimed to prevent the deterioration of the status of all bodies of groundwater.
- The Urban Waste Water Treatment Directive (91/271/EEC) (EU, 1991a) obliged Member States to collect and treat waste water from households and small businesses, and aimed to reduce organic pollution as well as nitrate and phosphorus discharges from these sources. It ended the dumping of sewage sludge to surface waters in 1998, reducing a significant source of hazardous substances in water.
- The Nitrates Directive (91/676/EEC) (EU, 1991b) regulated fertilisers and served to reduce nutrient

inputs from agriculture, especially from intensive livestock farming. (Nitrate is not a pollutant covered in this report.)

- The Drinking Water Directive (98/83/EC) (EU, 1998) set special quality requirements for water for human consumption. It set concentration limits for a range of hazardous substances, including total 'pesticides', benzo(a)pyrene, cadmium, lead, mercury, nickel and polycyclic aromatic hydrocarbons (PAHs). Some of these limits were based on analytical detection limits at the time.
- The Marine Strategy Framework Directive (2008/56/EC) (EU, 2008b) defined the target for the EU's marine waters to achieve or maintain good environmental status by 2020. For pollution, it set two qualitative descriptions of the marine environment when good environmental status has been achieved. Descriptor 8 sets out that concentrations of contaminants do not give rise to pollution effects and Descriptor 9 sets out that contaminants in seafood are at safe levels.

In addition to the water protection directives described above, there are various other policies and regulations that are not specifically aimed at protecting the environmental medium 'water', but are significant concerning chemicals in water:

- The Industrial Emissions Directive (2010/75/EC) (EU, 2010) set out rules on the integrated prevention and control of pollution arising from selected industrial activities.
- The Pollutant Release and Transfer Register Regulation (No 166/2006) (EU, 2006c) regulated the reporting requirements and supply of data to the EU for a European Pollutant Register, providing access to information on pollution. Under this regulation, operators must report emissions of pollutants if those exceed specified thresholds.
- The Plant Protection Products Regulation (No. 1107/2009) (EU, 2009a) set out rules for the authorisation of plant protection products and their marketing, use and control.
- The Directive on the Sustainable Use of Pesticides (2009/128/EC) (EU, 2009b) was aimed at reducing the risks and impacts of pesticide use on human health and the environment, and at promoting the use of integrated pest management and alternatives such as non-chemical approaches.

⁽²⁾ While introducing this comprehensive concept, the WFD repealed the former Dangerous Substances Directive (2006/11/EC) (EC, 2006a).

- The Biocide Regulation (No 528/2012) (EU, 2012a) focused on the marketing and use of biocide products.
 - The Sewage Sludge Directive (86/278/EEC) (EU, 1986) regulated the use of sewage sludge in agriculture to prevent harmful effects.
 - The Seventh Environment Action Programme (EU, 2013b) set the objective that, by 2020, the use of plant protection products should not have any harmful effects on human health or unacceptable influence on the environment, and such products should be used sustainably.
 - The Medicinal Products Regulation (No 726/2004) (EU, 2004) laid down Community procedures for the authorisation, supervision and pharmacovigilance of medicinal products for human and veterinary use.
 - The REACH Regulation (No 1907/2006) (EU, 2007) addressed the production and use of chemical substances and regulated the assessment of their impacts on human health and the environment.
 - The Classification, Labelling and Packaging Regulation (No 1272/2008) for chemical substances and mixtures complemented REACH (EU, 2008c).
 - The Strategic Environmental Assessment Directive (2001/42/EC) (EU, 2001) set out that, for large programmes, environmental impact assessment needs to be applied at an early stage of planning with a view to promoting sustainable development.
 - The basis for environmental impact assessment (EIA) under European Community law is provided in the EIA Directive (2011/92/EC) (EU, 2011). It prescribed the individual process stages of EIA and the project types for which an EIA must be carried out.
 - Regarding facilities that handle substances dangerous to water, an important part is also played by the EU Directive on the control of major-accident hazards involving dangerous substances (96/82/EEC) (EU, 1982), the Construction Products Directive (89/106/EC) (EU, 1989) and the standardisation procedure under CEN (Comité Européen de Normalisation).
- EEA member countries that are not members of the EU, but that have environment and water laws comparable to those of the EU, include Iceland, Liechtenstein, Norway and Switzerland.
- In addition, international agreements exist to limit the harm caused by particular chemicals:
- The Stockholm Convention on persistent organic pollutants (POPs) ⁽³⁾, effective from May 2004, aims to eliminate or restrict the production and use of POPs, such as several polybrominated diphenylethers (pBDEs) and several hexachlorocyclohexane (HCH) isomers (including lindane), which are addressed later in this report.
 - The Minamata Convention ⁽⁴⁾ on mercury came into force in 2017 and is designed to protect human health and the environment from anthropogenic emissions and releases of mercury and mercury compounds.
 - The International Commission for the Protection of the Danube River (ICPDR, 2018) is a collaboration of 14 countries. It aims to promote and coordinate sustainable and equitable water management, including conservation, improvement and rational use of waters for the benefit of the Danube River Basin countries and their people.
 - The Convention on the Protection of the Rhine (IKSR, 2018) is a cooperation between the five countries bordering the Rhine river, aiming at the preservation, improvement and sustainable development of the ecosystem.
 - The International Commission for the Protection of the Elbe River (ICPER, 2018) aims to promote the use of water, achieve the most natural ecosystem possible and decrease the burden on the North Sea.
- This long list demonstrates the critical role that water plays in the environment and human health.

⁽³⁾ <http://www.pops.int> (accessed 31 March 2018).

⁽⁴⁾ <http://www.mercuryconvention.org> (accessed 31 March 2018).

2 'Known unknowns' — unregulated micropollutants and chemical mixtures

2.1 Introduction

Under the WFD, the assessment of surface water quality is separated into chemical and ecological status. Such separation is a practical solution for water regulation but is an artificial separation for the environment. This chapter considers ways in which the chemical and ecological status of surface waters could be better linked in future.

Following the reduction of gross pollution, in recent years considerable effort has been put into

developing ways to assess the impact of chemicals at the organism level, towards answering the question 'what concentrations of which substances affect the healthy functioning of an ecosystem?' A better understanding could allow improved targeting of measures to reduce harmful concentrations of pollutants. Alongside this, concerns have grown about the 'cocktail effect', namely, mixtures of chemicals at low concentrations that, in combination, may cause harm. Some of the challenges in and proposed solutions to improving the assessment of the chemical risks in water are considered below.



2.2 Chemical status and ecological status/potential assessment

The WFD assesses the chemical and ecological status of surface water bodies separately ⁽⁵⁾. However, organisms living in the water experience an integration of all the influences present. The separation of these statuses can be criticised, as the reported 'chemical status' of a water body may be remote from what is actually occurring in the water ecosystem.

The chemical status of surface waters under the WFD is based on a comparison of measured concentrations of priority substances (set across the EU) with target levels established under the EQSD (EU, 2008a). Ecological status is assessed from monitoring data on biological quality elements (BQEs) such as benthic invertebrate fauna, phytoplankton, macrophytes and fish. In addition, data on hydromorphology (physical characteristics), physico-chemical water parameters and RBSPs can be used (Figure 2.1). Owing to the particular geographic circumstances of any particular

water body, ecological status is assessed in the context of specific local factors.

The benefit of measuring chemicals in rivers and lakes is that these concentrations can be directly compared between sites. Furthermore, they can be related to emission loads and, therefore, controls can be directed towards specific sources of chemical pollution. However, among the criticisms of this approach are that ecological structures and functions, key targets of chemical pollution, can be poorly related to specific chemical measurements. In particular, pollution by emerging compounds may be overlooked.

Efforts to link chemical occurrence and ecological effects are not required under the WFD, and failures to achieve good ecological status caused solely by individual chemical pollutants (e.g. RBSPs) are rarely observed. Assessment is complicated by a lack of data, as, in many water bodies, RBSPs have not been reported in the assessment of ecological status (Figure 2.2).

Figure 2.1 Existing approach to the assessment of chemical and ecological status under the WFD

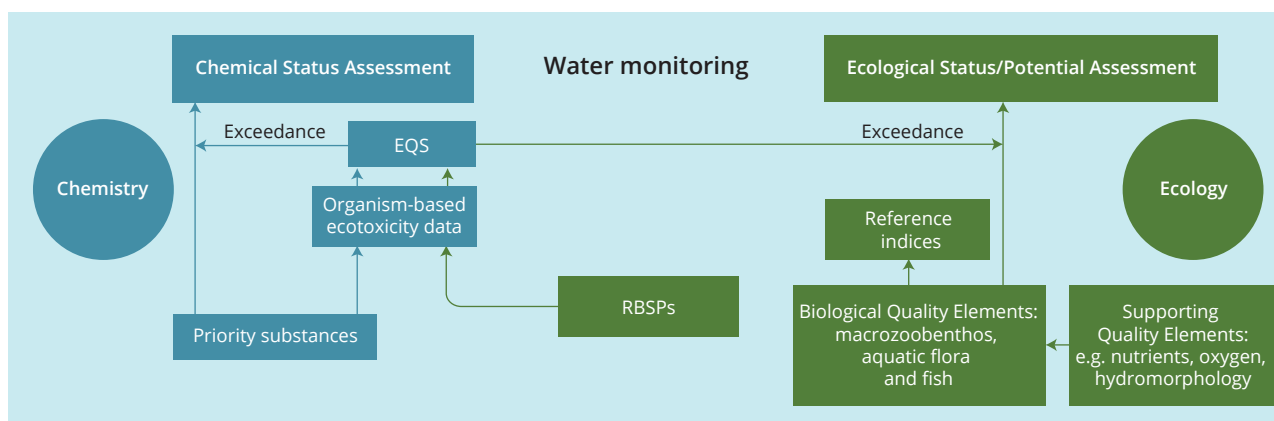

⁽⁵⁾ In artificial and heavily modified water bodies, assessment is made of chemical status and ecological potential.

Figure 2.2 Status of RBSPs in surface water bodies, by country

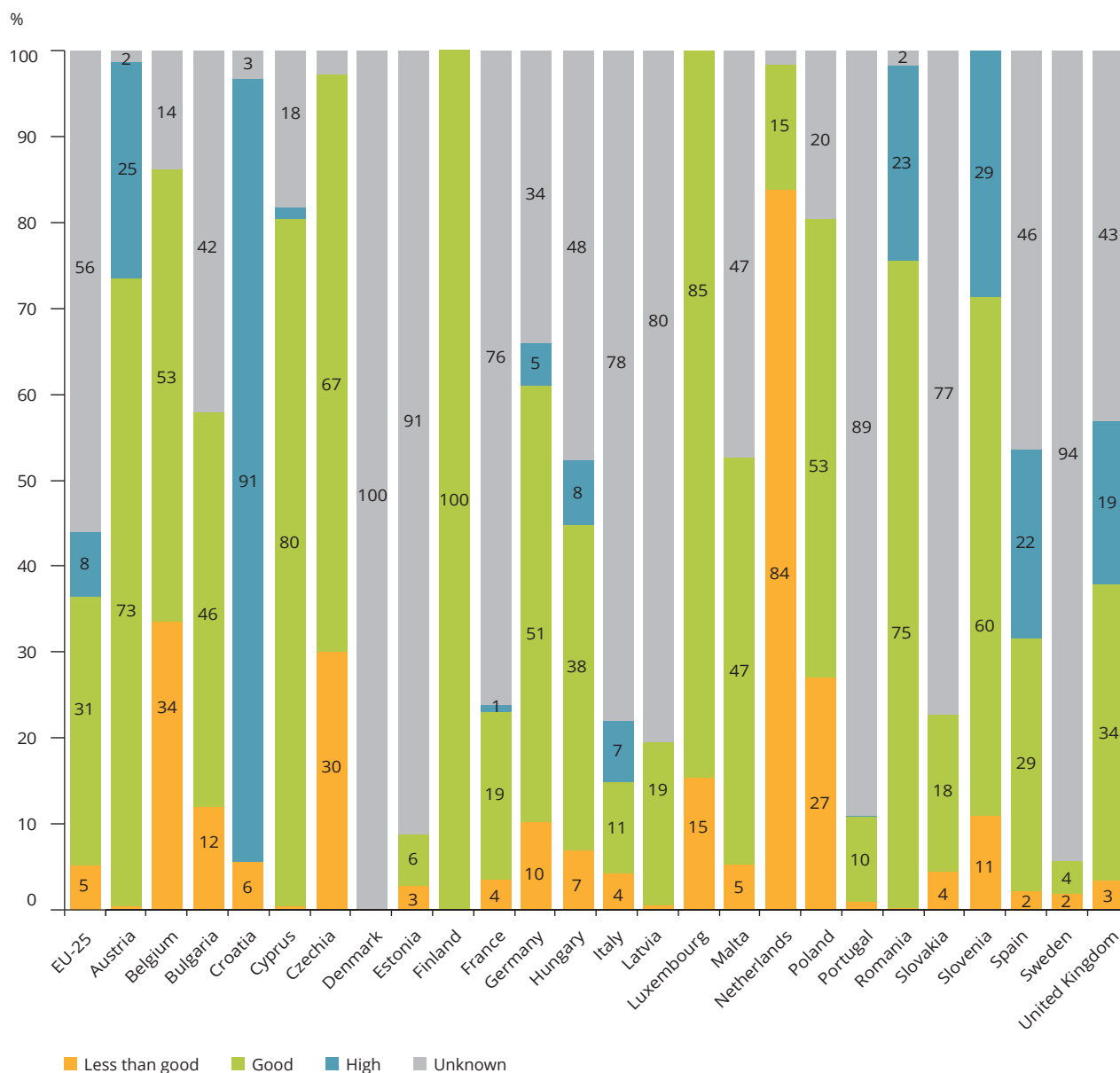

Notes: Data from the 'EU-25', i.e. the 25 Member States that had reported by June 2018 (i.e. the 28 EU Member States (as of 1 July 2013; the EU-28) minus Greece, Ireland and Lithuania). Countries took different approaches to reporting the status of RBSPs which met the EQS, including both good and high status. Further information on chemical status is available at: [Surface water bodies: Chemical status, by country](#).

Source: [QE3-3 — River Basin Specific Pollutants status in surface water bodies, by country](#).

However, reporting under the WFD for the second cycle of RBMP affords the opportunity to analyse the data for statistical relationships. Using the data for rivers and lakes, there are 73 510 natural water bodies with known chemical and ecological status (EEA, 2018b). For these water bodies, when good chemical status is not achieved, the risk of also not achieving good ecological status increases by 33 % (relative risk 1.33 with a 95 % confidence interval [1.315, 1.353]) (Table 2.1).

Table 2.1 Number of surface water bodies with known ecological and chemical status (including uPBTs)

Rivers and lakes	Failed to achieve good ecological status	Good ecological status
Failed to achieve good chemical status	25 108	16 313
Good chemical status	14 581	17 508

Note: uPBT is a ubiquitous, persistent, bioaccumulative and toxic substance, as defined in the Priority Substances Directive (EU, 2013a).

The analysis can be repeated using chemical status assessed without ubiquitous, persistent, bioaccumulative and toxic substances (uPBTs). When good chemical status is not achieved, the risk of also not achieving good ecological status increases by

66 % (relative risk 1.66 with 95 % confidence interval [1.625, 1.684]) (Table 2.2).

Table 2.2 Number of surface water bodies with known ecological and chemical status (without uPBTs)

Rivers and lakes	Failed to achieve good ecological status	Good ecological status
Failed to achieve good chemical status	1 732	241
Good chemical status	37 957	33 580

Note: uPBT is a ubiquitous, persistent, bioaccumulative and toxic substance, as defined in the Priority Substances Directive (EU, 2013a).

Therefore, there is a statistically significant association between poor chemical status and poor ecological status. A better understanding of the causal links could be used to indicate the effects of pressures and, potentially, explain causes of observed ecological effects, providing evidence for decision-makers. The scientific community has proposed diagnostic approaches to unravel the links between ecological effects and chemical contamination, and strong interest in this research has been indicated by stakeholders of water management (Brack et al., 2015) (Box 2.1).

Box 2.1 SOLUTIONS — pollutants in land and water management

This EU FP 7 project assessed how existing WFD practice could be brought up to date with the currently available scientific knowledge (Brack et al., 2015, 2017). Recommendations included:

- using effect-based methods for pollution investigation and assessment;
- using passive sampling for bioaccumulative pollutants;
- an integrated strategy for prioritising contaminants in monitoring;
- considering priority mixtures of chemicals;
- considering historical burdens accumulated in sediments;
- using models to fill data gaps;
- using a tiered approach in investigative monitoring to identify key toxicants.

<https://www.solutions-project.eu/project>

2.3 Evidence for chemical pollution causing ecological effects

The established way of identifying clear links between a chemical and its effect on organisms is through concentration-response relationships, for example by comparing an organism's health response to increasing concentrations of a chemical. As it is impossible to assess the sensitivity of all organisms to all pollutants, assessment factors are applied to accommodate uncertainties and data gaps, including chronic effects. Where an EQS has not been established for a substance, experimentally derived effect concentrations may be compared with estimated or measured environmental concentrations (Figure 2.3).

A pioneering study by Malaj et al. (2014) used monitoring data on chemical concentrations, based on data reported in the Water Information System for Europe — State of the Environment (WISE-SoE). The authors considered more than 200 substances monitored in European freshwater systems. They reported an acute risk at 14 % and a chronic risk at 42 % of the sites investigated using an individual chemical risk assessment approach (Figure 2.4 (A) and (B)). One issue identified using this approach, however, is that the expected risk increases with the availability of chemical monitoring data. Where concentrations are unknown, they cannot be used in the assessment and so this may result in a skewed result, with sites

for which information is available appearing worse than those for which this information is not provided (Figure 2.4(C)). A further issue is that the availability of data for acute toxicity is much greater than that for chronic toxicity, meaning that the chronic risk assessment is more dependent on assessment factors and thus is prone to larger errors.

Definitions

Acute toxicity — adverse effect on an organism after short-term exposure.

Chronic toxicity — adverse long-term effect after long-term exposure (typically at lower concentrations than those causing acute toxicity).

Mixture toxicity — adverse combined effect after exposure to multiple pollutants.

Mode of action — understanding of how a chemical acts in an organism or ecosystem.

Bioassay — biological test system (organism or cells).

Effect-based method — bioassay suitable for environmental monitoring.

Molecular target — biomolecule (e.g. protein) that directly interacts or binds with a chemical.

Figure 2.3 A possible risk assessment-type approach to link chemical and ecological status

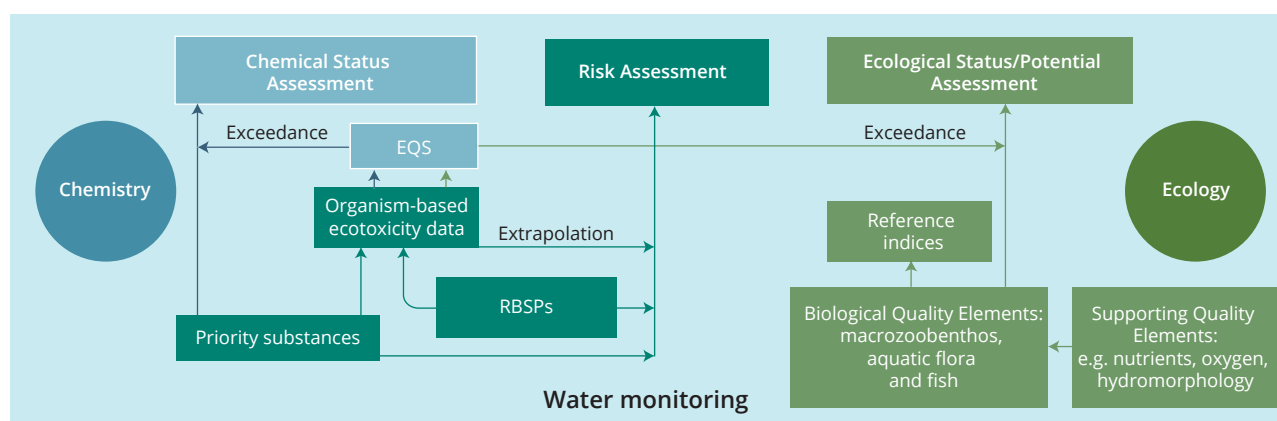

Note: Individual chemical risk assessment is based on a comparison between individual chemical concentrations in the environment and standards derived from measured effect concentrations (including factors to account for uncertainties).

Figure 2.4 Chemical risk (by percentage range) in European river basins: (A) Acute and (B) Chronic risk estimates for European river basin districts, based on reported chemical monitoring data and calculated using risk estimates for individual compounds; (C) Correlation between chemical risk and number of chemicals analysed for acute risk

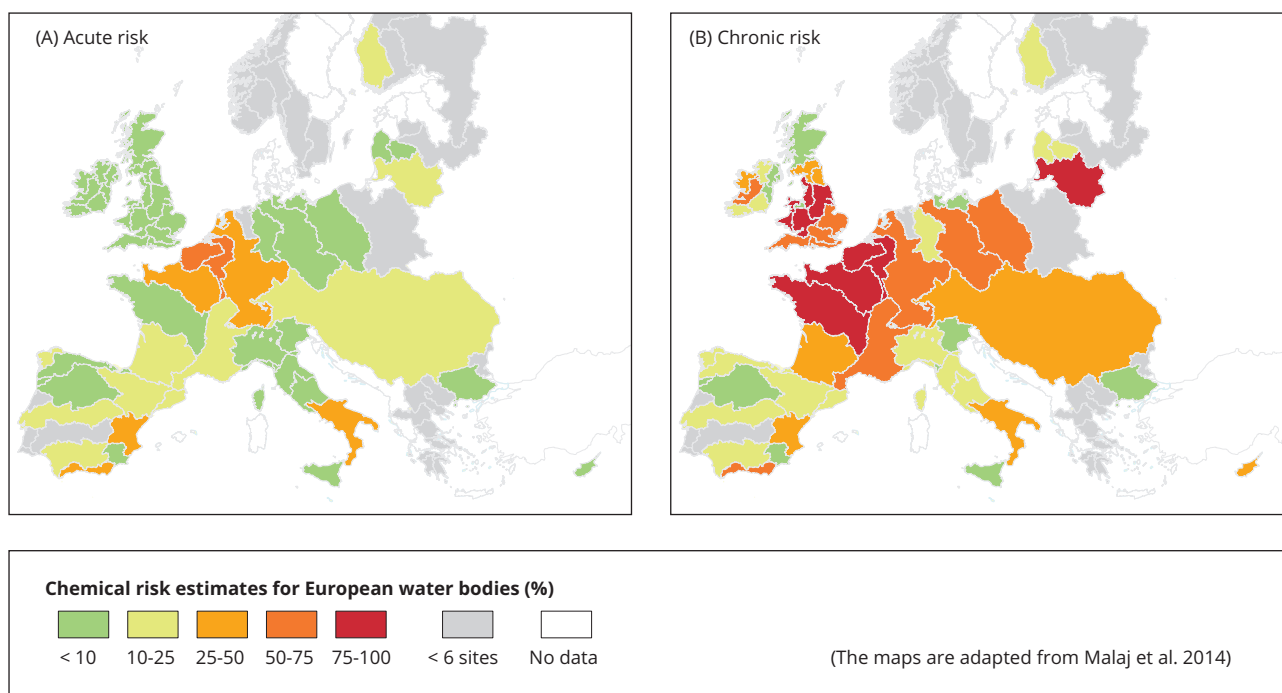

Notes: See text for discussion of potential bias in the data.

The map displays the fraction of sites where the maximum chemical concentration exceeds the acute risk threshold (A) and the mean chemical concentration exceeds the chronic risk threshold (B) for any organism group. The color code shows the level of chemical risk, from low chemical risk (green) to high chemical risk (red). River basins with up to six sites are displayed in grey, whereas river basins without data are displayed in white. Direct comparisons between river systems are potentially biased by the ecotoxicologically relevant compounds analysed and the limit of quantification of the compounds.

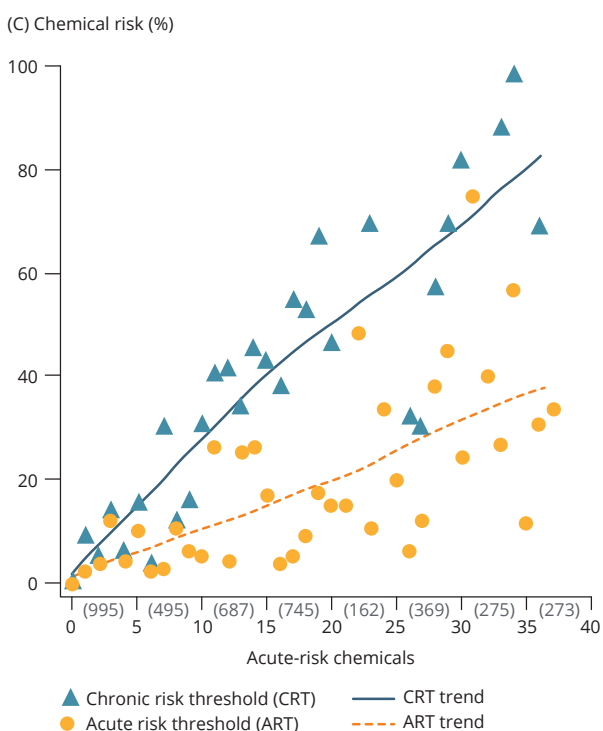

Note: Mean chemical risk of the river basins to exceed the risk thresholds as a function of the number of acute-risk chemicals (ARCs) analysed. ARCs are chemicals for which the maximum concentration exceeds 1/10 of the lethal effect concentration at any site. Dots correspond to the acute risk threshold (ART), and triangles are for the chronic risk threshold (CRT). The total number of sites for each ARC interval is given in parentheses on the x axis.

Source: Adapted from Malaj et al., 2014.

Recent research indicates that chemicals contribute to a significant but varying extent to the total effective stress in river ecosystems (Schäfer et al., 2016; Rico et al., 2016). Rico et al. (2016) showed that variation in invertebrate communities could, to a large extent, be explained by habitat and water quality, with physico-chemical parameters (e.g. dissolved oxygen) explaining more of the variation than metals or organic contaminants. The authors reported that it was difficult to find direct links between individual contaminants and ecological effects.

In the EEA's RBMP assessment (EEA, 2018a), it is highlighted that countries with good ecological status for benthic invertebrates also have lower levels of pressures. This seems true especially for diffuse pollution and hydromorphological pressures. To identify pressure-related failures of good ecological and chemical status, for example, might require a second line of assessment, beyond the prevailing basic one-out all-out principle. Such studies could be successful with pollutant concentrations instead of EQS exceedances and organism compositions instead of BQE classes.

In conclusion, it is rarely possible to explain observed effects in ecosystems based on knowledge about the presence of individual chemicals, while ecological impact information alone is similarly not sufficient to identify the chemicals causing that impact. Instead, multiple lines of evidence are needed.

2.4 Mixtures of chemicals

To establish causal relationships between chemical pollution and ecological effects, it has to be appreciated that, in the real world there are no cases where only a single substance occurs in the environment. Emissions data and research show that the aquatic environment has to deal with mixtures of chemicals, including many more substances than just priority substances. Nutrients from urban point sources, agricultural diffuse pollution, metals from stormwaters and atmospheric deposition, as well as many potentially harmful organic chemicals from urban waste water and agriculture, have been shown to be present in freshwater systems simultaneously. Indeed, scientific monitoring approaches highlighted the co-occurrence of hundreds of chemicals in different freshwater bodies (e.g. Loos et al., 2009, 2013; Moschet et al., 2014).

This complexity presents a mismatch with the single-substance approach of current chemicals assessment under the WFD. Indeed, as early as 2009, the Council of the European Union (2009), in its conclusions on 'combination effects', stressed that most EU legislation is built on a chemical-by-chemical assessment approach. The mandate to the Commission was to assess how, and whether, relevant existing European Commission legislation adequately addresses the risks posed by exposure to multiple chemicals from different sources and pathways and, on that basis, to consider appropriate actions.

The occurrence of chemical mixtures in freshwater systems is the result of different sources and different patterns in time, space and concentration (e.g. Baker and Kasprzyk-Hordern, 2013; Beckers et al., 2018) and so is the risk to ecosystems. The challenge is to figure out if combined adverse effects result from this and which of the many substances present are the most important for the toxicity of a mixture.

Efforts exist to simplify this complicated picture. In essence, these aim to separate and categorise the issues of pollution, impact and identification of key chemicals to achieve a problem-targeted assessment (Figure 2.5). Statistical methods are used to characterise complex pollution situations and relate these to sources (Posthuma et al., 2017). This approach offers the potential for identifying categories of mixtures as either 'typical' (i.e. commonly occurring) or 'priority' (i.e. containing substances that are of particular concern in a mixture, for instance because they promote toxicity). This is particularly relevant for the diverse and numerous organic micropollutants for which single representative candidates on lists of regulated substances are often outdated or which may be substituted by substances with potentially similar toxicity when regulation comes into effect. The combined action of similar compounds occurring together is not captured at all (Altenburger et al., 2015).

Examples of the co-occurrence of similar compounds include the neonicotinoid insecticides imidacloprid, thiacloprid and acetamiprid, which have been shown to occur simultaneously in water bodies, but also antibiotic drugs such as azithromycin, erythromycin and clarithromycin or herbicides, e.g. diuron and isoproturon.

Figure 2.5 Managing mixtures in water

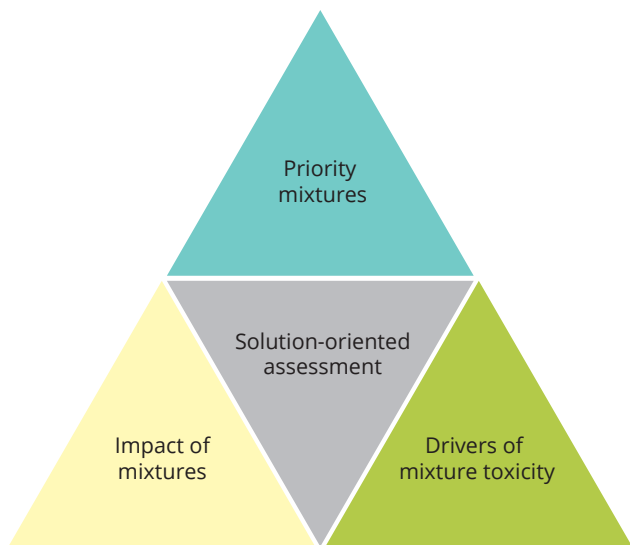

Notes: Water management can consider issues related to pollution (priority mixtures), effect (impact of mixtures) and risk (drivers of mixture toxicity).

Source: Modified from Altenburger et al., 2015.

A study by Busch et al. (2016) described the diversity of potential molecular targets for contaminant-biosystem interactions. In this study, 426 organic chemicals were detected in three European rivers, including 173 pesticides, 128 pharmaceuticals, 69 industrial chemicals and 56 other compounds. For about two-thirds of these compounds, the interactions with biological systems are known. These compounds can interact with more than 100 different biological molecules known to exist in aquatic organisms. This complicated picture was simplified by building broader categories of modes of action, into which the chemicals could be sorted because of their known biological target molecules or key events. For freshwater contaminants, 27 mode-of-action categories were identified (Figure 2.6); so even with a potentially unlimited number of chemicals, there was a limited range of adverse biological effects. While remaining aware of the fact that the development of toxicity is a complex process, with diverse events that might not be yet considered, this approach could serve as a starting point to simplify toxicity assessment.

The largest group of organic micropollutants with a known mode of action identified in this study were neuroactive compounds, which affect or interact directly with the nervous system. Chemicals that affect the nervous system interact with different molecular

Figure 2.6 Modes of biological action of organic micropollutants in three European rivers

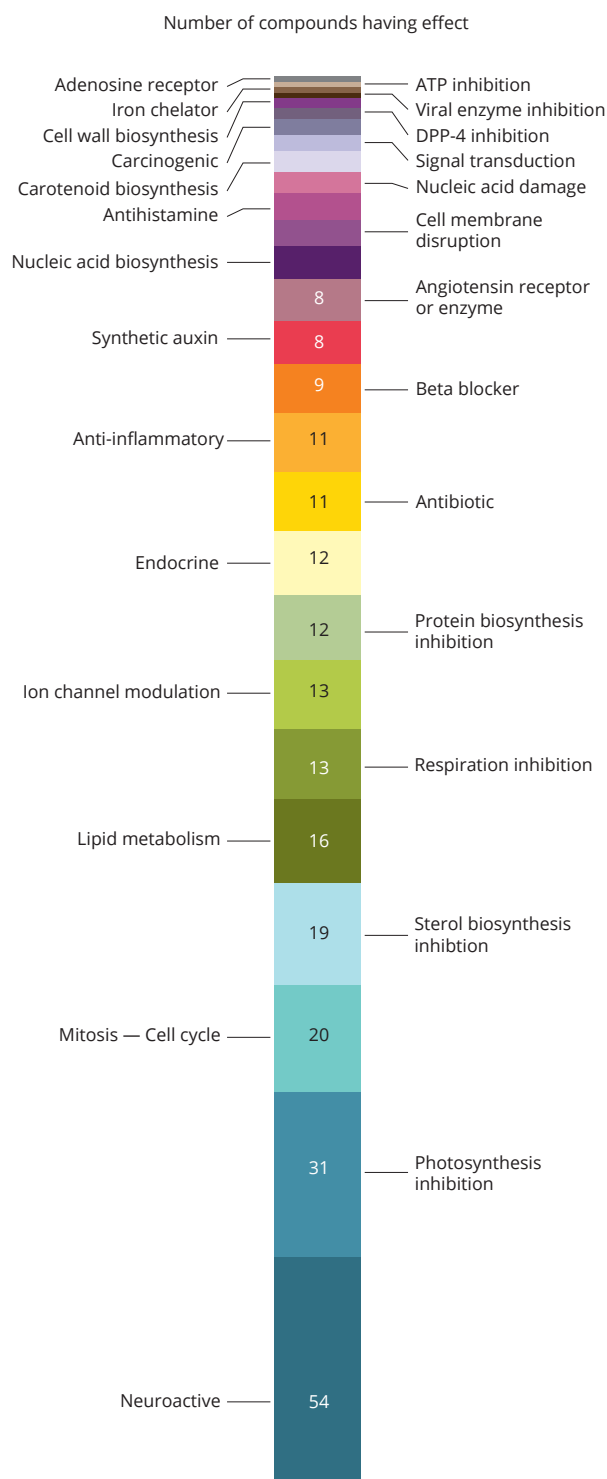

Notes: ATP, Adenosine triphosphate (energy carrier in the cells of all known organisms); DPP-4, dipeptidyl peptidase-4 (an enzyme).

Samples from sites in the Rhine, Danube and Mulde/Saale Rivers.

Source: Busch et al., 2016.

targets, e.g. different insecticides either binding to the nicotinic acetylcholine receptor or inhibiting the enzyme named acetylcholine esterase (Table 2.3). Both of these modes of action affect the signalling in the nervous system and mixtures of such chemicals will enhance the effects. Aquatic invertebrates might be particularly at risk owing to exposure to mixtures of different kinds of insecticides, while other species, such as fish, might be affected by the presence of antidepressant or antiepileptic pharmaceuticals that affect the nervous system of fish, possibly in combination with effects caused by insecticides. This means that chemicals, such as pesticides and pharmaceuticals, that are intended to act via certain modes of action in a certain

species can affect other species as well. For industrial chemicals, such as bisphenol A, PAHs and pBDEs, it is rather difficult to define a specific mode of toxicological action, as those can show complex and multiple modes of action. They have been found to cause different chronically relevant responses, indicating long-term toxicity such as endocrine disruption and mutagenicity, across various organisms including humans. The diversity of modes of action of the priority substances are summarised in a recent report from the Joint Research Centre (JRC) (Napierska et al., 2018), which illustrates the complexity of biological effects and indicates the potential application field of effect-based methods (see also Sections 2.6 and 2.7).

Table 2.3 Examples of mode-of-action categories and related mechanisms of chemical action (*)

Mode-of-action category	Mechanism	Chemicals known to act on/through this pathway
Neuroactive perturbation Chemicals interacting with the nervous system	Acetylcholine esterase (AChE) inhibition: AChE is an enzyme responsible for the depletion of the neurotransmitter acetylcholine; inhibition of AChE leads to increasing levels of this neurotransmitter and finally to a disruption of nervous system signalling.	Organophosphate insecticides, e.g. chlorpyrifos, diazinon
	Interaction with nicotinic acetylcholine receptor (nAChR): nAChR proteins respond to the neurotransmitter acetylcholine; chemicals that bind to nAChRs disrupt neurotransmission.	Neonicotinoid insecticides, e.g. imidacloprid, thiamethoxam
Photosynthesis or plant growth inhibition Chemicals disrupting processes in plants relevant for energy transformation, self-regulation, growth and development	Photosystem II (PSII) inhibition: inhibition of PSII proteins leads to energy breakdown and cell death.	Specific herbicides, e.g. diuron, isoproturon, atrazine
	Gibberellin pathway disruption: gibberellins are plant hormones that regulate growth and are involved in processes related to development and reproduction.	Specific herbicides, e.g. alachlor, metolachlor
Endocrine disruption Chemicals interacting with the hormone system of animals and humans	Estrogenic disruption: chemicals activating or inhibiting proteins of the estrogen pathway, such as the estrogen receptor, can cause chronic effects in organisms and populations leading to problems in reproduction.	Specific pharmaceuticals (e.g. 17 β -estradiol), several industrial chemicals (e.g. bisphenol A, 4-nonylphenol)
	Thyroid disruption: chemicals activating or inhibiting proteins for production, transportation and metabolism of thyroid hormones can cause chronic effects on reproduction, development and metabolism in organisms and populations.	Specific pharmaceuticals (e.g. carbimazole), several industrial chemicals (e.g. DDT, bisphenol A, PCBs, pBDEs)

Notes: (*) For further details see Busch et al., 2016.

DDT, dichlorodiphenyltrichloroethane; PCB, polychlorinated biphenyls.

It can be difficult to predict the outcome of chemical mixtures on biological effects. In broad terms, the chemicals might (1) act independently of each other, exhibiting individual toxicity; (2) act in combination and be more toxic, exhibiting the summed total of the individual chemicals or be even more toxic than that; or (3) be less toxic, as the chemicals interfere with each other in toxicity mechanisms. For chemicals in a mixture that have the same mode of action, an additive combination effect may be expected (Kortenkamp et al., 2009; Altenburger et al., 2015; Figure 2.7). Developing knowledge in this way, namely by considering effect contributions from all of the compounds detected, would be expected to provide a stronger association between chemical and ecological assessments.

Figure 2.7 Predicting the outcomes of mixtures — simplified model

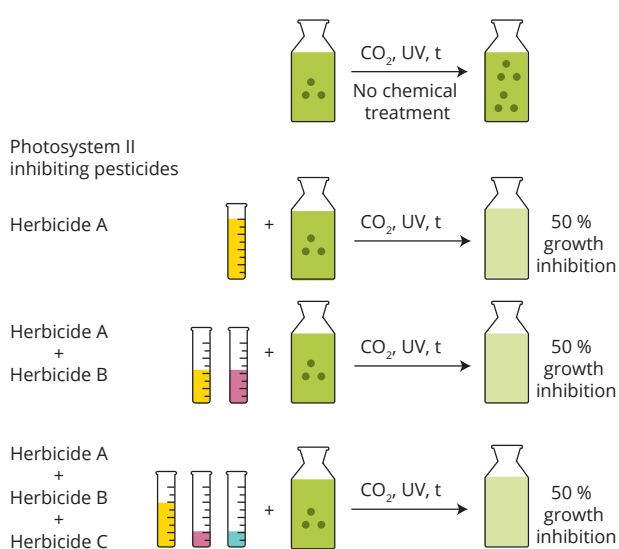

Note: This is a conceptual model showing how the concentration addition model can estimate the expected mixture toxicity, based on the toxicity of individual compounds.

2.5 Examples combining chemical and biological monitoring

While modern effect-based methods have been proposed for mixture assessment as a complement to chemical and ecological monitoring, precedent already exists in this respect. Such methods offer something similar to the biological oxygen demand (BOD), which

measures the overall condition of the water while not specifying the cause. Despite this lack of specificity, BOD is widely used in water management to protect surface waters (EU, 1991a, 2000).

Currently, there are few requirements for using effect-based information in regulatory assessment. An example in which effect-based monitoring is used for assessment is the Marine Strategy Framework Directive (EU, 2008b). Different descriptors of good environmental status, such as 'concentrations of contaminants at levels not giving rise to pollution effects', are defined and the assessment allows the integration of data on biological effects (Lyons et al., 2017). The application of bioassays for measuring the occurrence of dioxins and PCBs in foodstuffs demonstrates how effect-based assessment might operate in a regulatory framework, using a 'toxic equivalents' (TEQ) approach (EU, 2012b). The value of such information is that it integrates the effect of mixtures of chemicals, irrespective of whether the combined effects are additive or different from an expectation derived from knowledge on the mixture components.

For example, the total potency of compounds with estrogenic activity in a water sample can be determined by measuring the activity of the estrogen receptor in laboratory in vitro assays. Ideally, the bioassay captures the total effect of all chemicals with estrogenic effects in a sample. Practically, difficulties exist, although the robustness of techniques has improved for some modes of action in recent years (e.g. Kunz et al., 2017; Altenburger et al., 2018; Leusch et al., 2018).

For regulatory monitoring, techniques need to be robust and reliable to meet legal challenges and ensure that investments are based on sound evidence. A series of standardised methods of the International Organization for Standardization (ISO) is available for the use of biological methods for the assessment of effluents on water quality⁽⁶⁾. The EU water directives transposed into national regulation allow Member States to set requirements appropriate for the country level; for example, the German ordinance for waste water (AbwV, 1997) specifies standard methods for specified types of waste waters.

To demonstrate the application of biological effect tools in monitoring, case studies have been undertaken. In a pilot study by Escher et al. (2014), the efficacy of different waste water treatments was determined using the observable effects of enriched water samples in about 100 different miniaturised and mainly cell-based

⁽⁶⁾ <https://www.iso.org/committee/52972/x/catalogue> (accessed 14 November 2018).

bioassays (Figure 2.8). Results showed the presence of different chemicals at different levels of pollution with diverse modes of action.

Figure 2.8 Examples of organism and cell-based bioassays for water monitoring; scientists handling samples in front of an automated sampling device

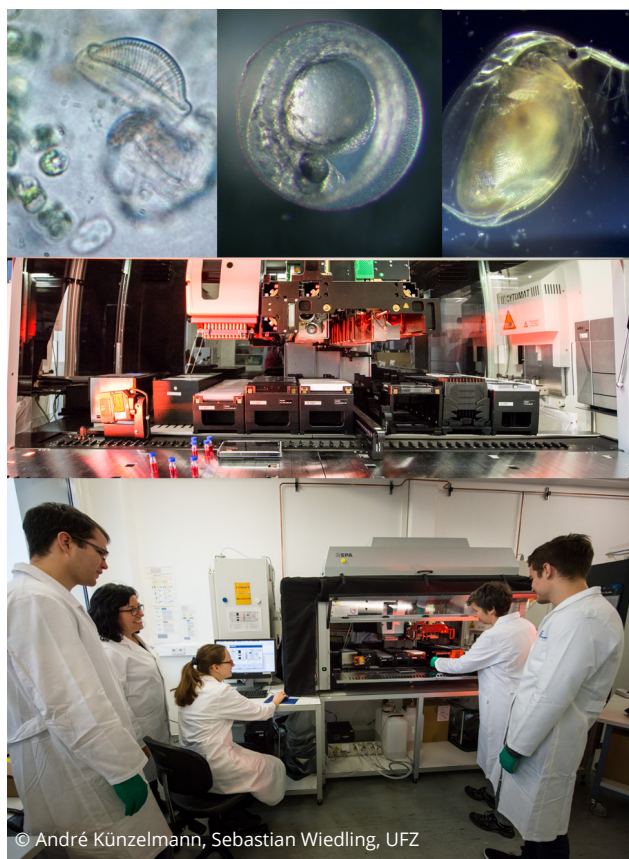

© André Künzelmann, Sebastian Wiedling, UFZ

In a case study performed within the European FP7 project SOLUTIONS, Neale et al. (2017) investigated UWWTP effluent, upstream and downstream river water samples in Switzerland. They compared bioanalytical results from 13 bioassays with results from chemical analysis of 405 compounds (see Figure 2.9A). Significantly, they found that, of the 10 detected herbicides known to inhibit PSII, terbuthylazine and diuron could explain the majority of biological effects on algae (Figure 2.9B). The authors also showed that the detected chemicals could explain between 45 and 108 % of the observed biological effects. In samples collected upstream of

the waste water treatment plant, only a fraction of the total measured effect could be explained by the detected chemicals.

Figure 2.9 Example of a comparative analysis of chemicals and combined effects using component-based mixture predictions

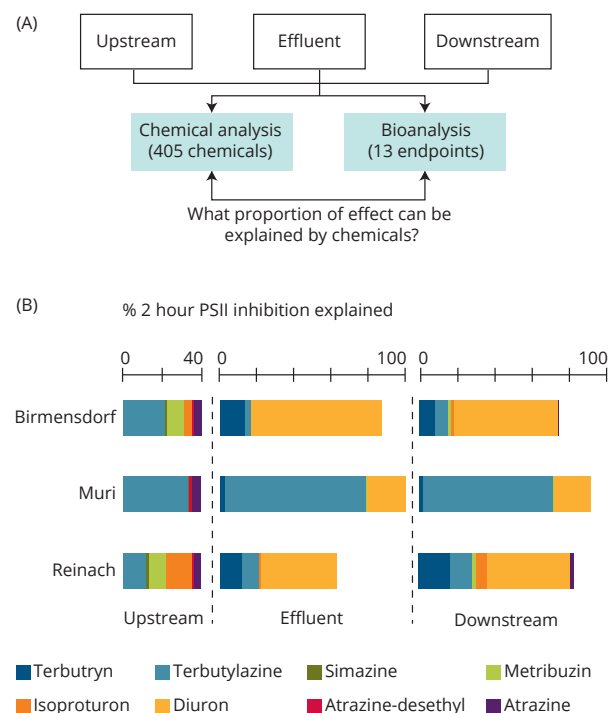

Note: Values < 1 are not shown in Figure 2.9B.

Source: Neale et al., 2017.

2.6 Towards monitoring and assessment of chemical mixtures

Assessment under the WFD currently does not consider combined effects of chemical mixtures. It is therefore possible that concentrations of priority substances could be slightly below their EQSs, and thus meeting good chemical status, while the actual combination of substances present could be harmful. This has been demonstrated by Carvalho et al. (2014). For example, if all five PSII inhibitors from the priority substances list were detected, individual concentrations might meet the EQS but the mixture could nevertheless cause adverse effects. In addition, while the list of priority

substances represents certain hazardous chemicals, there are other substances present in surface waters that may contribute to mixture toxicity.

Considerations of combined effects and potential mixture toxicity could be integrated into the existing assessment schemes, following three approaches that could be anticipated:

1. Compound-based mixture prediction: the EQS for mixtures of similarly acting compounds could be established and potentially considered in chemical status assessment. For example, an EQS for the sum of all six PSII inhibitors could be defined as the sum of the ratios of single substance concentrations over their individual substance EQS. If this sum exceeds 'one', then the EQS of priority PSII inhibitors is exceeded. Applying the concept of concentration addition ignores the occurrence of antagonistic and synergistic effects. However, many studies have proven the robustness and suitability of the concentration addition predictions for assessment purposes (Kortenkamp et al., 2009).
2. Extended monitoring: a longer list of chemicals whose concentrations in surface water bodies need to be monitored regularly would, in combination with mixture effect predictions, provide a more robust and realistic estimation of the impact of chemicals on the overall status of a water body.
3. Combined effect detection using effect-based methods: joint effects measured with a bioassay either instead of, or in addition to, single chemical compound concentrations might be

considered as indicators for the ecological status assessment. For example, instead of determining the concentrations of each PSII inhibitor in a water sample, the sample would be concentrated and tested in a dilution series using a bioassay (e.g. an algae growth inhibition test). At the point where the toxicity ceases, the dilution factor would be compared with the test result of a defined reference compound (e.g. diuron). Similar procedures are established for mixtures of dioxins and PCBs; for example, the Priority Substances Directive (2013/39/EU) (EU, 2013a) applies TEQs in the case of dioxins and dioxin-like compounds.

An example of a combination of these three approaches in a Swiss case study was published by Langer et al. (2017), who assessed water quality with mixture risk quotients. These were calculated for a set of 128 plant protection chemicals, in combination with the use of bioassays, which were indicative of a combined effect of the monitored compounds.

Currently, several whole organism-based assays, and some cell-based assays, are ready for routine use in effect-based monitoring. This is important as readiness for use implies that requirements regarding standardisation, robustness and reproducibility will be fulfilled. While there are many techniques available to researchers, we lack specific bioassays for several modes of action. Within the WFD water quality assessment, selection of the relevant bioassay could be derived from the BQEs assessed in the water body. Organism-based bioassays therefore could support the link between chemical and ecological monitoring and assessment (Figure 2.10).

Figure 2.10 Biological effect assessment could serve to close the gap between ecological and chemical assessments and demonstrate causal relationships

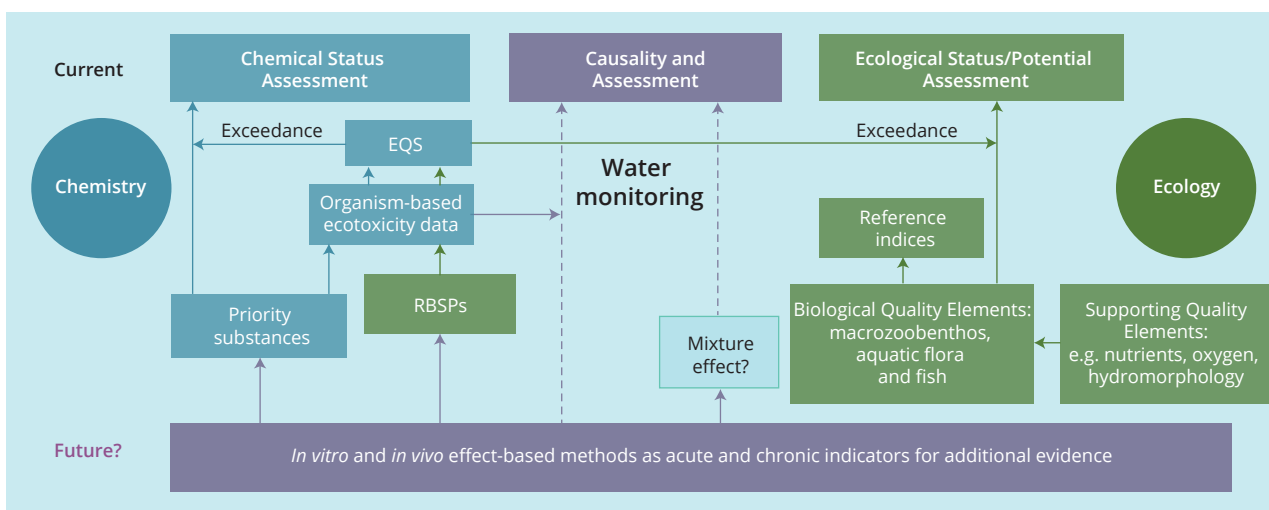

The European Commission (Wernersson et al., 2014) gives a summary of the available bioanalytical tools in the technical report on aquatic effect-based monitoring tools under the WFD. Their readiness for monitoring applications has been evaluated in several projects (e.g. Kienle et al., 2015; Napierska et al., 2018). These tools can be applied and used in a modular manner, depending and targeted on the desired level of evidence (Escher et al., 2014; Altenburger et al., 2018; Figure 2.11).

The following are possible applications of effect-based methods:

- **The monitoring of chemical impact on BQEs.** For effect-based monitoring, a module comprising different organism-based bioassays representing the different BQEs would provide evidence for the integrated impact of chemicals. It would also enable direct linkage of effect observations with ecological monitoring data (Figures 2.10 and 2.11(A)). However, to detect chemicals with impacts that emerge over a longer time scale, such as endocrine disruptors or mutagenic and genotoxic compounds, additional bioassays, such
- **Investigations of pollutants that cause effects.** When investigating chemicals that could be causing effects through specific modes of action (Table 2.3) or on specific stress-related endpoints, additional bioassays are available (Figure 2.11 (C) and (D)). The application of such in vitro detectors may also be used to protect specific uses of a water body, e.g. drinking water abstraction.
- **Toxicity reduction evaluation.** Effect-based methods can be applied to evaluate the efficiency of management measures, e.g. remediation efforts.
- **Effect-directed analyses to identify drivers of mixture toxicity.** The most advanced option for the use of effect-based methods is in conjunction with sample fractionation and chemical analysis to identify drivers of mixture toxicity (Brack et al., 2016).

Figure 2.11 Modular approach for the application of bioassays in monitoring

Module-based bioassay battery for monitoring	
Monitoring	(A) Integrated effects bioassays (related to WFD BQE) <ul style="list-style-type: none"> · Alga growth inhibition test · Water flea immobilisation test · Fish embryo toxicity test
	(B) Cellular bioassays indicative for chronic effects <ul style="list-style-type: none"> · Cell-based assays detecting mutagenicity and/or genotoxicity · Receptor-based assays detecting endocrine activity (e.g. ER, AR, TR)
Diagnosis	(C) Bioassays indicative for specific groups of compounds (via known mode of action) <ul style="list-style-type: none"> · Photosynthesis inhibition test · AChE inhibition test · EROD assay
	(D) Bioassays indicative for specific molecular responses <ul style="list-style-type: none"> · Additional receptor-based assays (AhR, GR, PPARγ, PXR, etc.) · Additional bioassays indicative for inflammation, oxidative stress, etc.

Notes: AhR, aryl hydrocarbon receptor; AR, androgen receptor; ER, estrogen receptor; EROD, ethoxyresorufin-O-deethylase; GR, glucocorticoid receptor; PPAR γ , peroxisome proliferator-activated receptor gamma; PXR, pregnane-X-receptor; TR, thyroid hormone receptor.

2.7 Challenges

The implementation of effect-based methods within monitoring routines or diagnostic screening approaches would require agreement on the bioassays to be used. Robust bioassays have been developed for some organisms (e.g. for invertebrates such as *Daphnia*) and some assays have been developed for the detection of estrogenic compounds, with detailed recommendations for application in monitoring (e.g. Kunz et al., 2017). For other methods, standardisation in relation to the intended usage has to be advanced.

Broadening the use of analytical techniques to better link chemical and ecological status assessment under the WFD is summarised in Figure 2.12.

Figure 2.12 Combination of existing approaches for characterising a water body

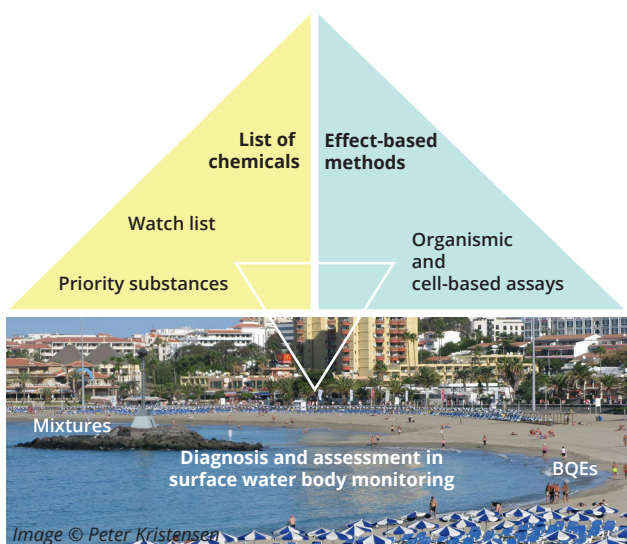

In addition to ongoing efforts regarding standardisation and further development of additional bioassays, there are other limitations as to what can be reasonably expected from such efforts, with both scientific and practical considerations, such as:

- Chemical analysis of freshwaters is limited to what has been looked for, be that through targeted, screening or untargeted analytical strategies. The limitations are specific for each approach.
- Complementary use of effect-based methods needs to consider which tests should be used.

- Effect-based methods rely on concentrating the dissolved substances in a water sample through solid-phase extraction methods. Such methods work well for some organic compounds (non-polar compounds) but not for others (e.g. polar compounds including glyphosate and AMPA) (Reemtsma et al., 2016). Neither metals nor contaminants bound to particles will be detected by the effect-based methods discussed and these would thus need separate analysis. This is a significant omission given the relatively widespread failure of metal EQSs (Johnson et al., 2017; EEA, 2018a). However, most metals are well known, can be accurately measured and have extensive ecotoxicity data available that allow for the derivation of a reliable EQS. Therefore, traditional substance-based monitoring for metals is well established, and the need for effects-based methods is less pressing than for other substances that may be unknown, difficult to measure and/or have highly uncertain EQSs.

2.8 Summary

The major advantage of incorporating mixture assessment and biological effect detection is that the effects of chemical pollution can be identified more comprehensively, allowing further bridging between chemical and ecological status.

Most effects-based methods do not provide conclusive evidence of the chemical(s) responsible. That requires further, site-specific, effort, which is where scientific technique meets a regulatory approach based on individual substances. Water managers need to first identify which components of the mixture are the main contributors to harmful effects and, second, to reduce those inputs. However, this approach is not entirely new — BOD has been used for many years as an integrated measure of water pollution.

In relation to chemical status assessment under the WFD, the inclusion of techniques more sensitive to chemical pollution is likely to make it more difficult to achieve good chemical status. While this situation may reflect expert opinion based on current scientific knowledge on 'real chemical status', it would represent further difficulties in communicating progress under the WFD. One option could be for effect-based methods to be used as part of ecological status assessment.

3 Known risks: key pollutants and their sources

3.1 Introduction

At the European level, our knowledge of the chemical status of water is largely based on regulatory requirements, which demand information on well-established key pollutants. In the WFD, most priority substances are already subject to use restrictions under the REACH Regulation or pesticides legislation, while RBSPs are usually subject to national legislation. So why do we still see failures to achieve good status for these substances? This chapter considers key chemical pollutants and why these continue to pose challenges to good water quality in Europe.

When the assessment of status under the WFD finds a failure, the reasons for this failure — the 'pressures' — need to be investigated as a step towards identifying measures that might be taken to achieve good status in the water body. Therefore, here we consider the priority substances most frequently causing failure to achieve good chemical status and the RBSPs most frequently causing failure to achieve good ecological status. For example, improved waste water treatment or altering farming practice can help to reduce the amount of harmful chemicals reaching the aquatic environment.

It is important to appreciate that this is where the WFD meets chemical source control legislation. Environmental monitoring undertaken for the WFD provides information for legislation, such as REACH, on the effectiveness of the source control. However, because some chemicals are persistent and can remain in the environment for a long time, we also need information on the trend to assess whether or not and how concentrations are changing. At the European level, there is limited comparable information about concentrations of hazardous substances over time. To get around that issue, reporting on the trends in chemical emissions can provide

complementary information on the status of chemicals in the environment. For the key priority substances, emissions data reported under the E-PRTR, the WFD and the WISE-SoE reporting are presented. Conclusions about our level of understanding and the areas where actions need to be taken are provided.

3.2 Chemical status, RBSPs and pollutants most frequently exceeding standards in Europe

Under the WFD, the chemical status of surface waters is assessed using EQSs for a list of priority substances. EQSs are set to protect the most sensitive species — this could be, for example, algae or invertebrates but could also be top predators such as fish or humans, which may eat many smaller organisms and cause the pollutant to 'bioaccumulate'. The first list of priority substances included 33 substances and groups in the EQSD. The list of priority substances was updated in the Priority Substances Directive (7).

A summary of the findings regarding the chemical status of surface waters from the recent RBMP assessment is provided in Box 3.1 (EEA, 2018a).

Examining these findings further, the priority substances and RBSPs most often exceeding environmental standards under the recent WFD reporting are shown in Table 3.1. This table shows the priority substances and most of the RBSPs that caused failure in at least four Member States (8). To better understand the pressures resulting in particular chemicals failing to achieve good status, the substances have been grouped according to the main pressure or pathway through which that substance is generally understood to reach the aquatic environment. Substances have been included when exceedances were reported from at least four Member States.

(7) The 2013 Priority Substances Directive contains a revised list of 45 priority substances and groups of substances. In the EEA status and pressures assessment (EEA, 2018a), Member States were required to use the 2008 EQSs for reporting, although some applied a more stringent approach than others, using the 2013 EQSs.

(8) A further six natural chemical elements exceeded standards for RBSPs in at least four Member States (barium, selenium, boron, cobalt, uranium and thallium).

Box 3.1 Key messages on chemical pollutants from EEA's RBMP assessment (EEA, 2018a) ^(a)

- A total of 38 % of surface water bodies in the EU were in good chemical status. 46 % were not in good status and for 16%, the status was reported as 'unknown'.
- In most Member States, a few priority substances accounted for poor chemical status, the most common being mercury. If mercury and other ubiquitous priority substances were omitted, only 3 % of surface water bodies would have failed to achieve good chemical status. Improvements for individual substances showed that Member States made progress in tackling the sources of contamination.
- A comparison of the chemical status reported in the first and second RBMP periods shows that the proportion of water bodies with unknown chemical status dropped significantly, from 39 % to 16 %.
- Chemical pollutants are or have been emitted into water bodies through a range of pathways and from a variety of sources, including industry, agriculture, transport, mining and waste disposal, as well as from our own homes. Significant levels of some priority substances have built up from historical use and this legacy pollution may persist in water bodies long after pollutant discharges and inputs have ended.
- The outlook for chemical status in Europe's waters is challenging; since 2015 stricter standards for some priority substances have been coming into force, and new substances will be added to the priority substances list for the third RBMP.
- Of the thousands of chemicals in daily use, relatively few are reported under the WFD. There is a gap in knowledge at European level over whether any of these other substances present a significant risk to or via the aquatic environment, either individually or in combination with other substances. In addition, information on the sources and emissions of many pollutants remains incomplete, limiting the scope for identifying and targeting appropriate measures.

Note: ^(a) Numbers accurate as of 30 August 2018.



Table 3.1 List of pollutants most frequently exceeding EQSs in surface water bodies in the Member States that reported under the WFD by February 2018 (the EU-25) (out of a total of 111 105 water bodies)

Pollutant	Type/use of chemical	Number of Member States with EQS exceedance	Number of water bodies with EQS exceedance ^(a)	Priority substance (PS)/RBSP ^(a)
Contamination mainly through atmospheric deposition (Section 3.4)				
Mercury	Metal	22	45 739	PS ^(b, c)
Benzo(g,h,i)perylene + indeno (1,2,3-cd)-pyrene	PAH	13	3 080	PS ^(b, c)
Fluoranthene	PAH	13	1 324	PS
Benzo(a)pyrene	PAH	11	1 627	PS ^(b, c)
Benzo(b)fluoranthene + benzo(k)fluoranthene	PAH	10	460	PS ^(b, c)
Anthracene	PAH	9	102	PS ^(b)
Phenanthrene	PAH	4	68	RBSP
Contamination mainly from urban settlements (Section 3.5)				
DEHP	Plasticiser	11	101	PS ^(b)
4-Nonylphenol	Surfactant	8	184	PS ^(b)
pBDEs	Flame retardants	7	23 320	PS ^(b, c)
Contamination from metals — mining and use (Section 3.6 ^(d))				
Cadmium	Metal	19	991	PS ^(b)
Nickel	Metal	18	600	PS
Lead	Metal	17	413	PS
Zinc	Metal	18	1 454	RBSP
Copper	Metal	16	808	RBSP
Arsenic	Metalloid	14	385	RBSP
Chromium	Metal	10	110	RBSP
Cyanide (total + free)	Ion	8	72	RBSP
Contamination mainly from agriculture (Section 3.7)				
HCH	Insecticide	10	104	PS ^(b)
Isoproturon	Herbicide, biocide	7	198	PS
MCPA	Herbicide	6	159	RBSP
Metolachlor	Herbicide	6	139	RBSP
Terbutylazine	Herbicide	6	51	RBSP
2-4 D	Herbicide	4	18	RBSP
Malathion	Insecticide	4	13	RBSP
Parathion	Insecticide	4	7	RBSP
Contamination mainly from navigation (Section 3.8)				
Tributyltin-cation	Biocide	14	659	PS ^(b, c)

Notes: For an explanation of the criteria and structure of the table, see the description in the text.

^(a) Under the WFD, EU-wide standards apply for priority substances, while national or river basin standards apply for RBSPs.

^(b) Defined as priority hazardous substances, for which all discharges, emissions and losses must be ceased.

^(c) Substance is a uPBT, as defined in the Priority Substances Directive.

^(d) Another six chemical elements exceeded standards for RBSPs in at least four Member States (barium, selenium, boron, cobalt, uranium and thallium) plus PCBs.

Sources: WISE-Freshwater WFD accessed 20 August 2018. Data from the 'EU-25', namely the 25 Member States that had reported by June 2018 (i.e. the 28 EU Member States (as of 1 July 2013; the EU-28) minus Greece, Ireland and Lithuania).

Priority substances: [Surface water bodies: Priority substances in the 2nd River Basin Management Plans](#) (substance causing failure 'yes', chemical status 'failing').

RBSPs: [Surface water bodies: River basin specific pollutants](#) ; [Surface water bodies: River basin specific pollutants reported as 'Other'](#) (ecological status 'moderate', 'poor' or 'bad').

It can be seen from Table 3.1 that the chemicals causing the most failures in chemical status are mercury and pBDEs. Other substances causing failure do so in many fewer water bodies.

3.2.1 Legacy pollutants

One of the challenges in status assessment is that some chemicals can be present in the aquatic environment a long time after they were originally discharged or emitted. This 'persistence' means that, even after effective measures have been put in place to prevent pollution, the chemical can still cause poor water quality, because some chemicals do not break down and are instead recycled through sediments, water and organisms. Typical situations are mining districts and those areas that received industrial effluents when there was little regulation (see Box 3.4). In the case of mercury, while coal burning continues to be a current source, there is now more regulation to prevent losses. However, historic and natural sources have led to widespread pollution of soils and waters in central and northern Europe.

3.3 Emission sources and pathways

Having identified the substances causing poor water quality, the WFD requires that an investigation be undertaken of the pressures causing this. In the reporting of the second cycle of RBMPs, there was no direct link between a substance failing in a water body and the pressure(s) causing that failure. Therefore, we looked at reporting under the E-PRTR, the WFD inventory of emissions, discharges and losses of priority substances and the WISE-SoE emissions. The aim was to identify trends in chemical discharges, given the difficulty of disentangling historic from current pollution, to see whether emissions were increasing or decreasing.

There are different approaches to recording emissions (Figure 3.1). One approach looks at the emissions from a known source, e.g. a manufacturing or waste water treatment plant. This 'source-oriented' approach addresses the whole system, starting from the principal sources of substance release. Pathways are the routes by which substances can be transported to the aquatic environment, with the 'pathway-oriented' approach modelling where pollutants may be temporarily stored (e.g. in soils) before eventually reaching surface waters through other processes,

e.g. erosion or stormwater overflows. The 'riverine load-oriented approach' estimates the observed total load in the river and can include an estimate of the diffuse and point source inputs. Riverine loads describe the mass of the pollutant transported in the river. Both the WFD inventory and WISE-SoE emissions allow reporting under each of these three approaches. While accommodating different approaches, these diverse methods can make it difficult to compare results.

Both point source (from a known discharge) and diffuse source (from multiple sources in an area) should be covered by emissions reporting. In practice, reporting of point sources is generally more straightforward than reporting of diffuse sources, and the former dominates emissions reports.

A general scheme setting out the principal sources, pathways and intermediates has been developed under the WFD for the inventory of emissions, discharges and losses of priority substances, as shown in Figure 3.1 (EC, 2012).

Figure 3.1 provides a way to compare emissions reported under the different approaches. On the left-hand side of the figure, the principal sources of the pollutants are shown, representing groups of sources. Emissions, discharges or loads can follow different pathways, either directly to surface water or to other compartments of the environment (i.e. air, soil or groundwater), represented by the middle section of the figure. Emissions can be the result of losses during production or as a result of the use of products. Some of the waste water from industry and households is collected in a sewer system and treated in industrial waste water plants (P10) or UWWTPs (P8), as shown on the right-hand side of the figure. UWWTPs can be seen as a secondary source.

In this chapter, the main pathways are considered, but substances have other ways of entering the aquatic environment.

3.3.1 Emissions datasets provided in Figures 3.2 to 3.14 (further detail is provided in Annex 1)

The E-PRTR contains data from large sources, either industry or UWWTPs serving over 100 000 people (or equivalent), with loads above the E-PRTR threshold value. Data have been reported under this EU obligation since 2007.

Figure 3.1 Relationship between the different surface water compartments and pathways (P1-P13)

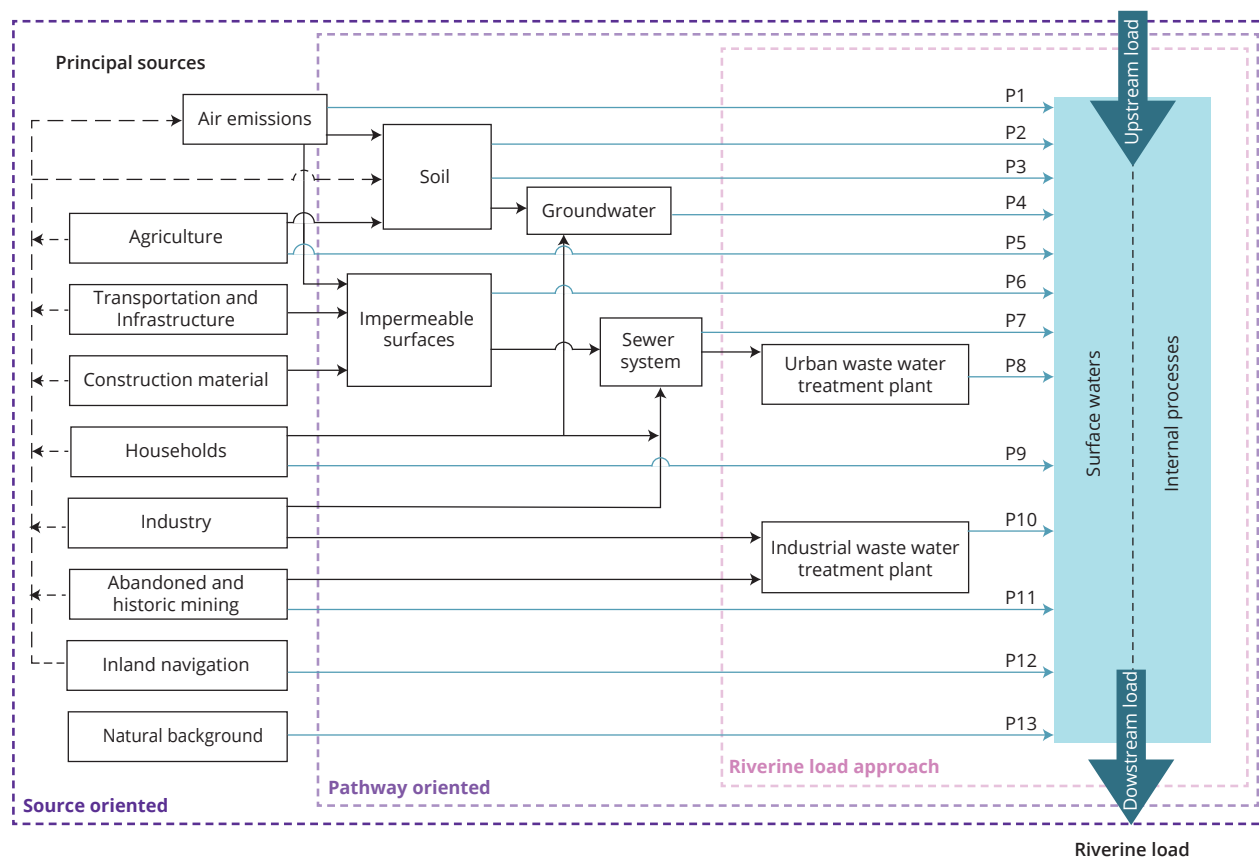

P1, Atmospheric deposition directly to surface water
 P2, Erosion
 P3, Surface run-off from unsealed areas
 P4, Interflow, tile drainage and groundwater
 P5, Direct discharges and drifting
 P6, Surface run-off from sealed areas
 P7, Stormwater outlets and combined sewer overflows and unconnected sewers

P8, Urban waste water treated
 P9, Individual (treated and untreated) household discharges
 P10, Industrial waste water treated
 P11, Direct discharges from mining
 P12, Direct discharges from navigation
 P13, Natural background

Source: EC, 2012.

The WFD requires reporting of the emissions inventory for each river basin district, which was required for priority substances for the first time in the second cycle of RBMP reporting, i.e. for 2010. Following the recommendations of EU Technical Guidance No 28 (EC, 2012), some countries reported emissions only for substances identified as relevant for the river basin.

WISE reporting is voluntary and involves reporting of emissions by EEA's member countries. Not all countries report to WISE and those that do may not report all pollutants.

Any datasets labelled 'Estimated diffuse 2010' are those from a project calculating diffuse loads to surface waters. Data are limited to a selection of key sources and pollutants (Roovaart et al., 2013a, b).

The WFD inventory should contain information on priority substances. The emissions data given below therefore focus on emissions reporting of priority substances, although more information is available on RBSPs (EEA, 2018c; Roovaart et al., 2017).

3.3.2 What should the emissions data tell us?

In Figures 3.2-3.14, the lowest emissions estimate would be expected to be the E-PRTR, as these reports include emissions from large installations only. We would expect the WISE-SoE data to be the same as or higher than the E-PRTR. WFD data, which should include all the losses, emissions and discharges, ought to be higher than the E-PRTR. However, this is often not the case and it is unclear which are the most accurate values.

The WFD inventory reporting was expected to provide data on emissions of priority substances into each river basin. Our study of the emissions therefore focused on the priority substances identified as key pollutants in Table 3.1.

However, **owing to the limited reporting and poorly comparable data, little information can be gleaned from the WFD emissions inventory.**

One of the major reasons for differences between the reported emissions in the different datasets results from large differences in the number of countries reporting. More specific details on the emissions datasets can be found in Annex 1.

3.4 Contamination through atmospheric deposition

EEA's RBMP assessment (EEA, 2018a) showed that atmospheric deposition was the major source of contamination of Europe's surface waters.

3.4.1 Mercury and its compounds

Sources and uses

Mercury is a natural substance. It can enter the environment from coal burning and industrial processes, such as in the chlor-alkali process for commodity chemicals and cement manufacturing. The largest release reported under the E-PRTR is into the air from the energy sector (EEA, 2018d). Mercury is also released during volcanic eruptions. It has had many historical uses, which have since been phased out (e.g. thermometers, dental amalgam and hat making). It has no known essential function for living organisms.

Toxicity and EQS

Mercury and its compounds are toxic and can accumulate in the food chain. Microbial methylation can occur in water, converting inorganic mercury to more toxic organo-mercury compounds. Methylation can also occur in organic environments, such as in organisms and in humic substances, and is thought to be one of the reasons that 'unpolluted' areas such as Scandinavia show high mercury content in biota (Pirrone et al., 2010).



© Andrzej Bochenski, ImaginAIR/EEA

The EQS is derived to protect predators such as sea eagles or otters from secondary poisoning through eating contaminated fish. In particular, it protects against methyl mercury, which accumulates in the food chain. Fish consumption can be an important source of mercury to humans, for whom fish plays a significant role in the diet.

WFD status

Mercury and its compounds are ubiquitous priority hazardous substances and have caused failures to achieve good chemical status in nearly all Member States, in a total of 41 % of Europe's surface water bodies (Table 3.1a). Despite it being a well-characterised historic pollutant, there was widespread variation in the degree to which mercury did not meet the EQS — from 1-100 % of surface water bodies (Map 3.1).

Table 3.1a List of pollutants most frequently exceeding EQSs in surface water bodies in the EU-25 (out of a total of 111 105 water bodies)

Pollutant	Type/use of chemical	Number of Member States with EQS exceedance	Number of water bodies with EQS exceedance ^(a)	Priority substance (PS)/RBSP ^(a)
Contamination mainly through atmospheric deposition (Section 3.4)				
Mercury	Metal	22	45 739	PS ^{(b), (c)}
Benzo(g,h,i)perylene + indeno(1,2,3-cd)-pyrene	PAH	13	3 080	PS ^{(b), (c)}
Fluoranthene	PAH	13	1 324	PS
Benzo(a)pyrene	PAH	11	1 627	PS ^{(b), (c)}
Benzo(b)fluoranthene + benzo(k)fluoranthene	PAH	10	460	PS ^{(b), (c)}
Anthracene	PAH	9	102	PS ^(b)
Phenanthrene	PAH	4	68	RBSP

Notes: ^(a) Under the WFD, EU-wide standards apply for priority substances, while national or river basin standards apply for RBSPs.
^(b) Defined as priority hazardous substances, for which all discharges, emissions and losses must be ceased.
^(c) Substance is a uPBT, as defined in the Priority Substances Directive.

Map 3.1 Impact of mercury on chemical status of surface water bodies

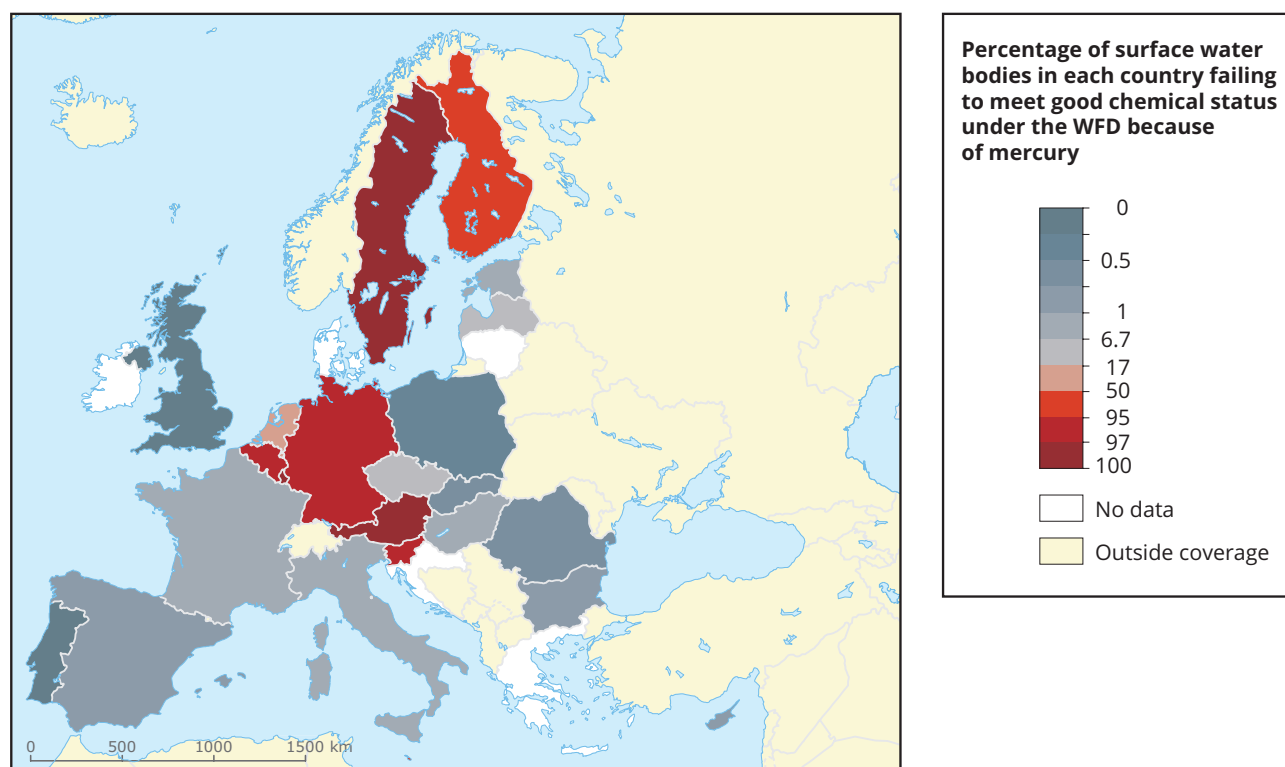

Source: EEA, 2018c.

If comparing results between countries, it should be noted that there were different approaches towards the monitoring and reporting of mercury for the second cycle of the RBMP. Member States took different approaches towards interpreting the data. Some countries extrapolated failure to meet the standard at monitoring sites to all water bodies, while others reported failure only where failure was confirmed (EEA, 2018a). Typically, measurements of mercury in biota extrapolated to all similar water bodies led to reporting of widespread failure to meet the EQS.

Emissions

The concentrations of mercury in water depend on geology, historical pollution in sediments, concentrations in precipitation and industrial emissions. Mercury can enter surface waters through direct emissions, such as from UWWTPs and industry. As it is readily released as a vapour, it can be widely distributed through atmospheric deposition in dust and rain.

Figure 3.2 summarises the data available for mercury emissions into water in Europe. Many countries report mercury emissions, giving confidence in the data. For 2015, a conservative estimate of the total mercury emitted into European surface waters is 2 tonnes from industry, 4 tonnes from UWWTPs and 2.5 tonnes of direct deposition from the atmosphere.

Emissions from UWWTPs, which receive inputs from many sources, are known to be under-reported (Roovaart et al., 2013b). In 2010, these missing emissions were estimated as being 8.4 tonnes. Data reported under the WISE for 2014-2015 indicate atmospheric deposition as an important pathway, corroborating the information provided under the WFD. From modelled atmospheric deposition mapping (EMEP, 2018), it can be estimated that approximately 44 tonnes were deposited in the whole of the EU (land and surface water) (Box 3.2). A significant part of this 44 tonnes will end up in surface water via the following pathways: erosion, run-off from paved surfaces, stormwater overflows and UWWTPs.

Outlook

Although mercury emissions have decreased over recent decades, this is unlikely to result in an improvement within a few years in the chemical status of surface water bodies. Mercury will continue to be recycled between water, sediments and biota. Meanwhile, mercury that is transported to marine waters concentrates in top predators, such as tuna and shark, leading health authorities to issue advisory restrictions on human dietary intake (EEA, 2018e).

Atmospheric deposition is an important source of mercury to European surface waters. Loads from atmospheric deposition and from industry are declining as a result of action to reduce emissions. However, further effort to reduce atmospheric emissions of mercury from the energy sector seems necessary.

Figure 3.2 Existing emissions data for mercury (tonnes per year)

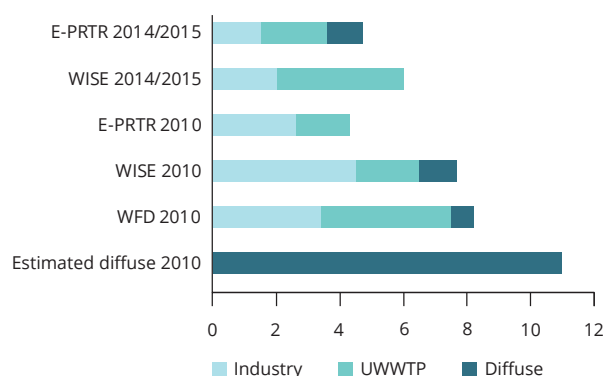

Note: Loads given in these figures cannot be summed, as there may be double counting.

3.4.2 Polycyclic aromatic hydrocarbons

Sources and uses

PAHs are a natural component of coal and oil, which have historically been used in wood preservatives and tar products. They are mainly formed by incomplete combustion of organic material, such as coal, petrol and wood, and are commonly released into the atmosphere as small particulates (Abdel-Shafy and Mansour, 2016). Sources of PAHs into the European environment include the production and processing of metals, vehicle exhausts, coal-fired power generation, domestic heating and forest fires. Atmospheric emissions have been reduced in Europe since the 1980s.

Box 3.2 Modelling atmospheric emissions of mercury

Modelled data for emissions of mercury into the air go back further in time than direct emissions, providing more information on the trend over time. According to modelled emissions, the trend of emissions into the air in the EU-28 is declining from 109 tonnes in 2005 to 58 tonnes in 2016. Some of the emissions into the air will finally result in atmospheric deposition on land and surface waters, which can also be modelled. In Map 3.2, mercury atmospheric deposition in 2016 is shown (EMEP, 2018). In Europe, the anthropogenic mercury deposition is derived almost equally from European and overseas emissions.

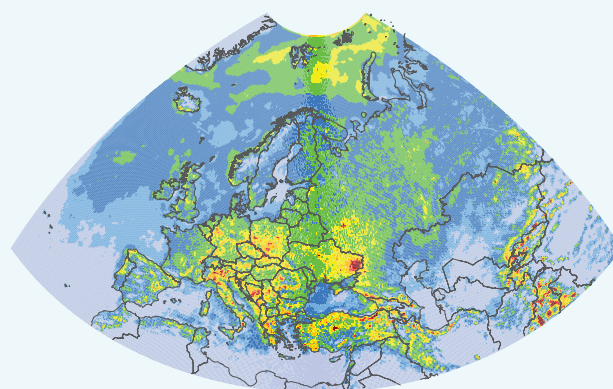

Simulated annual mercury total deposition flux in 2016 over the EMEP domains



Source: <http://en.msceast.org/index.php/pollution-assessment/emep-domain-menu>



© Trevor Littlewood

Toxicity and EQS

The PAH substance group comprises a large number of substances with different toxicities and environmental fates (EC, 2011a). EQSs have been set for seven of the most toxic PAHs, which act as representatives of the whole group. Three of these are separately listed (anthracene, fluoranthene and naphthalene) while the other five are grouped, with the 'lead substance' being benzo(a)pyrene.

PAHs cause cancer (e.g. they are present in cigarette smoke). The EQS is set to protect humans, the most sensitive species, with exposure being through consumption of fishery products.

WFD status

PAHs cause failures to achieve good chemical status in hundreds to thousands of surface water bodies (Table 3.1a) across 9 to 13 Member States. There is, however, some skewing of the results — over 1 000 water bodies failed to achieve good chemical status owing to benzo(a)pyrene in Germany and owing to benzo(g,h,i)perylene plus indeno(1,2,3-cd)-pyrene in France.

Emissions

For most PAHs, only a limited number of countries report emissions into water from industry and UWWTPs. There is more reporting of fluoranthene and anthracene, but still from fewer than half of European countries. This limited reporting means that trends can be skewed by one-off reports of high loads (9). Emissions into the air, reported under the E-PRTR, show that the processing and production of metals are the main sources of anthracene, benzo(g,h,i)perylene and fluoranthene.

Figures 3.3-3.5 give an overview of the different reported loads for anthracene, benzo(a)pyrene and fluoranthene. For all PAHs, industry and UWWTPs seem to be significant sources. Atmospheric deposition directly to surface water is the largest reported pathway, taking into account the small number of countries that report.

An overview of the total emissions into water in Europe cannot be given for the PAHs. The data appear to be too inconsistent to assess any trends, owing to the limited number of countries reporting and inconsistent reporting between datasets.

Figure 3.3 Existing emissions data for anthracene (tonnes per year)

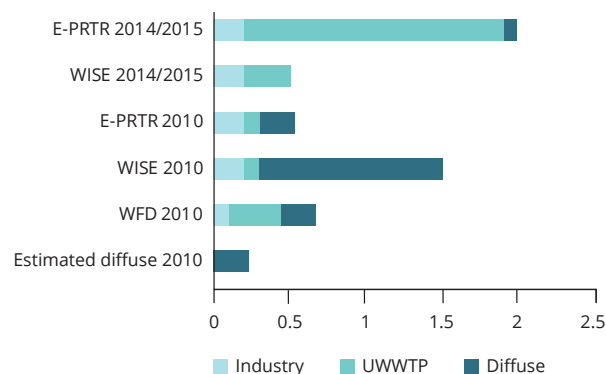

Figure 3.4 Existing emissions and deposition data for benzo(a)pyrene (tonnes per year) (*)

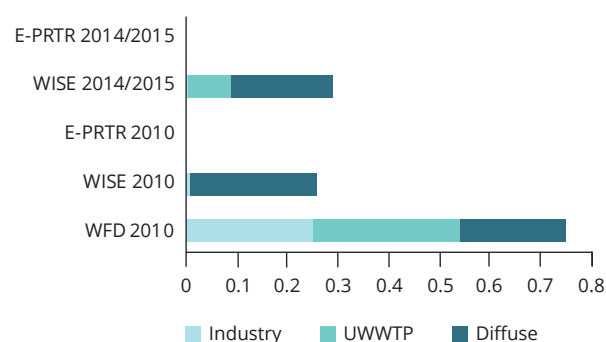
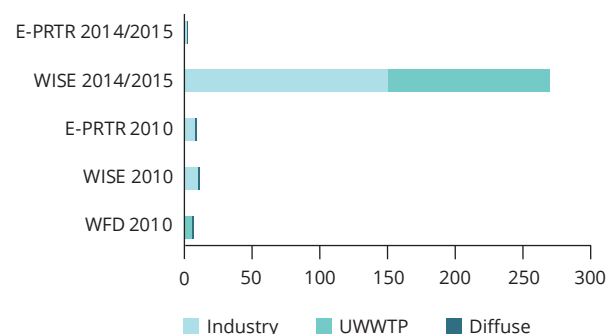

Figure 3.5 Existing emissions data for fluoranthene (tonnes per year)



Notes: Loads given in these figures cannot be summed, as there may be double counting.

(*), CAUTION — low confidence in data, as there has been limited reporting of this substance (see Table 3.2). Details on the emissions data are given in Annex 1.

(9) Emissions reporting from WISE 2014/2015 regarding fluoranthene from industry: 150 tonnes by one country, but 0.7 tonnes by 12 other countries. Emissions reporting from WISE 2014/2015 regarding fluoranthene from UWWTPs: 120 tonnes by two countries, but 0.2 tonnes by five other countries.

Emissions into the air have fallen substantially since 1990 (EEA, 2018f). The main sources to air are now from industry, transportation and domestic use.

Summary/outlook

PAHs are atmospheric pollutants with multiple sources, resulting from the burning of organic matter. Reducing pollution by PAHs of water bodies will remain challenging. A shift to electric vehicles would address some diffuse sources, while tackling those from domestic heating (as wood or coal) requires sustained and significant effort.

The low level of reporting of emissions of well-characterised pollutants such as PAHs is disappointing. Improved emissions reporting could help explain the main pressures causing PAHs to pollute surface waters, enabling the identification of more effective measures to tackle these pollutants.

3.5 Contamination from urban settlements

The EEA's RBMP assessment (EEA, 2018a) showed that contamination from urban waste water treatment was the major point source of contamination of Europe's surface waters. Note that, in most cases, such treatment plants are the recipients of contaminants from upstream uses and discharges, providing a known pathway into the aquatic environment, rather than they themselves being the users of hazardous substances. Measures to reduce pollutant discharges into the

environment could involve reducing use or release of the substance at the source and/or enhancing urban waste water treatment.

3.5.1 Bis(2-ethylhexyl) phthalate

Sources and uses

DEHP is a widely used phthalate, for example as a plasticiser in the manufacturing of PVC. It has other uses, such as in hydraulic fluid, as a dielectric fluid in capacitors, as sealing compounds in buildings and as an additive in paints, cosmetics and biocides. Although its use is being phased out under REACH, the widespread use of DEHP in, for example plastic water pipes represents a potential source of release into the environment for many years to come, owing to the long lifetime of those products.

Toxicity and EQS

DEHP is persistent in sediments and soils, but does not bioaccumulate in organisms. The main harmful effect is endocrine disruption to aquatic organisms, adversely affecting reproduction and growth.

WFD status

Despite its widespread use, DEHP caused failures in relatively few water bodies (Table 3.1b). This may be because it is relatively well removed by conventional waste water treatment, concentrating into the sludge (Gardner et al., 2014).

Table 3.1b List of pollutants most frequently exceeding EQSs in surface water bodies in the EU-25 (out of a total of 111 105 water bodies)

Pollutant	Type/use of chemical	Number of Member States with EQS exceedance	Number of water bodies with EQS exceedance ^(a)	Priority substance (PS)/RBSP ^(c)
Contamination mainly from urban settlements (Section 3.5)				
DEHP	Plasticiser	11	101	PS ^(b)
4-Nonylphenol	Surfactant	8	184	PS ^(b)
pBDEs	Flame retardants	7	23 320	PS ^(b, c)

Notes: ^(a) Under the WFD, EU-wide standards apply for priority substances, while national or river basin standards apply for RBSPs.

^(b) Defined as priority hazardous substances, for which all discharges, emissions and losses must be ceased.

^(c) Substance is a uPBT, as defined in the Priority Substances Directive.

Emissions

Figure 3.6 gives an overview of the different reported loads.

Figure 3.6 Existing emissions data for bis(2-ethylhexyl)phthalate (DEHP) (tonnes per year)

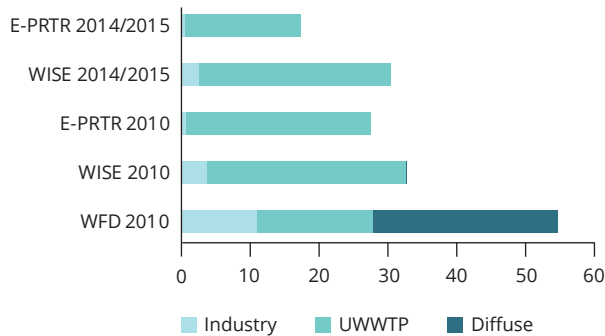

Note: Loads given in these figures cannot be summed, as there may be double counting.

About half of the Member States, plus Norway, reported DEHP loads from industry and UWWTPs, showing that UWWTPs represent the most significant point source. There seems to be a declining trend in reported loads from industry, while trends from UWWTPs are harder to assess owing to large fluctuations in some reported loads. Emissions of diffuse sources are difficult to compare owing to different approaches used by different countries and low levels of reporting. Important diffuse sources seem to be stormwater overflows and households not connected to the sewerage system.

Outlook

The major source of DEHP appears to be via UWWTPs, although diffuse sources may also be significant (Figure 3.6). Over time, the replacement of DEHP in plastics should lower the concentrations of DEHP reaching UWWTPs.

While it is hard to assess trends from the existing data, the decades-long lifetime of products containing DEHP would suggest that chemical status is unlikely to change much without significant effort to reduce emissions from UWWTPs, whether that is at the plant itself or by preventing discharges into the sewerage system, e.g. through waste controls.

3.5.2 Nonylphenol

Sources and uses

Nonylphenol is a precursor in the production of nonylphenol ethoxylates (NPEs), used in manufacturing as antioxidants, lubricating oil additives, emulsifiers and solvents. It acts as a surfactant, such as in wetting agents or detergents. Until restriction under REACH, it was found in paints, pesticides, imported textiles and personal care products. When NPE was used in clothes, much of it seemed to enter the sewerage system following the washing of clothes in domestic washing machines (Environment Agency, 2013).

In urban waste water treatment, NPEs break down to nonylphenol.

Toxicity and EQS

Nonylphenol is toxic for aquatic organisms, particularly for algae and invertebrates (CIS WFD, 2005). It has endocrine-disrupting effects, particularly on fish.

WFD status

Nonylphenol was reported as causing failures to achieve good chemical status in eight Member States, mainly in western Europe. Half of the failures were reported as being in France.

Emissions

Figure 3.7 gives an overview of the different reported loads.

Figure 3.7 Existing emissions data for 4-nonylphenol (tonnes per year)

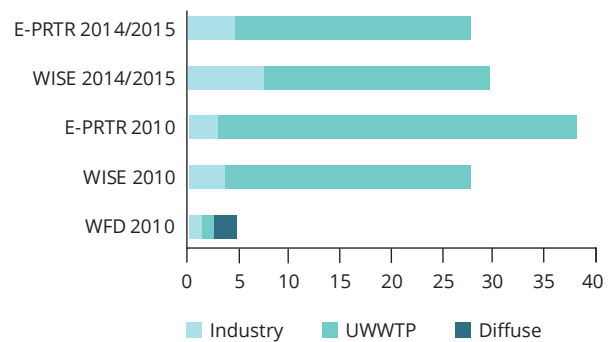

Note: Loads given in these figures cannot be summed, as there may be double counting.

About half of the Member States, plus Norway, reported loads from industry and UWWTPs. Trends for industry seem to be increasing, but those for UWWTPs seem to be decreasing. A few Member States reported diffuse sources for the WFD inventory, suggesting that unconnected households, stormwater overflows and run-off were the main pressures, but limited reporting makes assessment difficult.

Overall, it is difficult to be confident in the emissions data for nonylphenol, because extreme differences between Member States suggest different approaches to monitoring or quantification.

Outlook

Restrictions on the use of nonylphenol and NPEs should lead to a decline in emissions into water. However, nonylphenol is persistent (Mao et al., 2012), so it may take some time for restriction to result in fewer failures of good chemical status.

3.5.3 Polybrominated diphenylethers

Sources and uses

pBDEs are a group of 209 substances that have been used in many products, such as flame retardants. They have been used, for example, in electronics, furniture and textiles (EPA, 2017).

Toxicity and EQS

pBDEs are ubiquitous in the environment and some are restricted under the Stockholm Convention owing to their widespread use and very persistent and bioaccumulative properties. A group of six representative pBDEs is regulated under the WFD⁽¹⁰⁾. The EQS is set to protect human health, as pBDEs can be consumed in fishery products.

WFD status

The EQS for pBDEs was exceeded in 21 % of surface water bodies. Seven Member States reported failures to achieve good chemical status for pBDEs, the vast majority of which were in Sweden (23 185 water bodies of the total 23 320 not meeting the EQS) (see Table 3.1b).

Emissions

Figure 3.8 gives an overview of the different reported loads.

Figure 3.8 Existing emissions data for pBDEs (tonnes per year) (*)

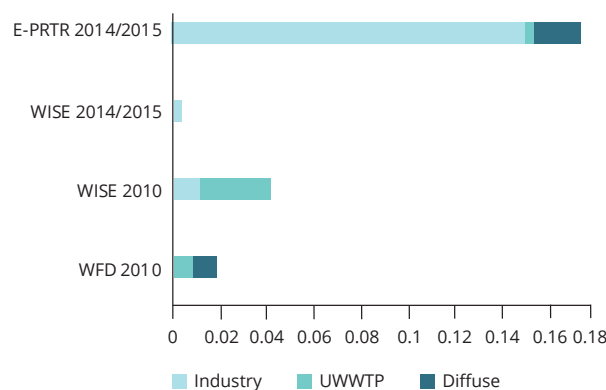

Notes: Loads given in these figures cannot be summed, as there may be double counting.

(*), CAUTION — low confidence in data, as there has been limited reporting of this substance (see Table 3.2). Details on the emissions data are given in Annex 1.

There is very little reporting of emissions of pBDEs. The few Member States reporting to the WFD inventory show that the highest loads are from industry, followed by diffuse sources and UWWTPs. The few reported diffuse loads suggest atmospheric deposition and households may be relevant sources. Consequently, it is difficult to offer anything quantitative about total emissions into water in Europe or to discuss trends. Studies can offer some insight (Box 3.3).

In contrast with many substances used historically, such as mercury, pBDEs began to be widely used as flame retardants only in the early 1990s. Environmental concerns began to be identified within a few years, with a Directive setting out restrictions on the use of pentaBDE and octaBDE in 2003 (2003/11/EC) (EU, 2003). In 2008, pBDEs were included in the list of priority hazardous substances under the EQSD and, in 2009, pentaBDE and octaBDE were listed under the Stockholm Convention, along with

⁽¹⁰⁾ For the group of priority substances covered by pBDEs, the EQS refers to the sum of the concentrations of congener numbers 28, 47, 99, 100, 153 and 154. Four of them — tetra-, penta-, hexa- and heptabromodiphenylether (CAS numbers 40088-47-9, 32534-81-9, 36483-60-0 and 68928-80-3, respectively) — are regulated as priority hazardous substances.

Box 3.3 pBDEs in fish in German rivers (data from the German Environmental Specimen Bank)

Germany shows widespread and very high exceedance of the EQS for pBDEs (shown by the red line in figure (A) below). Figure (B) shows the trends between 1995 and 2013 varying between different rivers. The Rhine shows decreasing concentrations, while concentrations in other rivers are mostly increasing.

(A) Concentrations in 2013

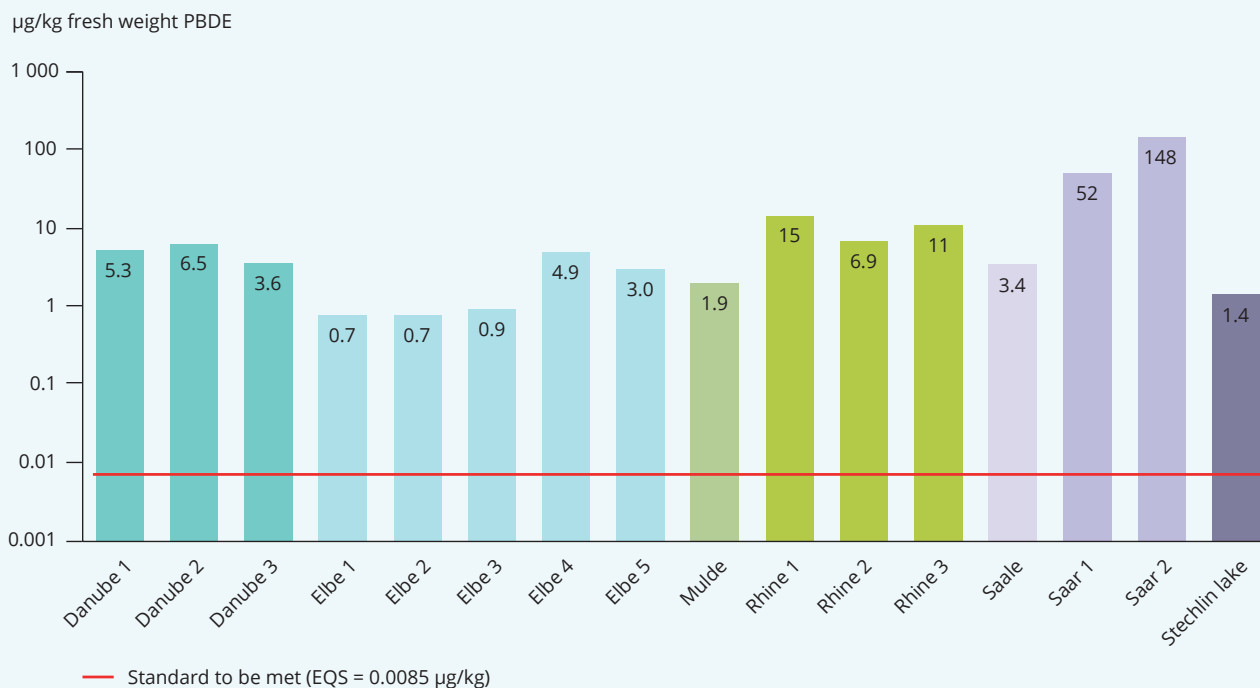

(B) Trend in concentrations of pBDEs in fish (%)

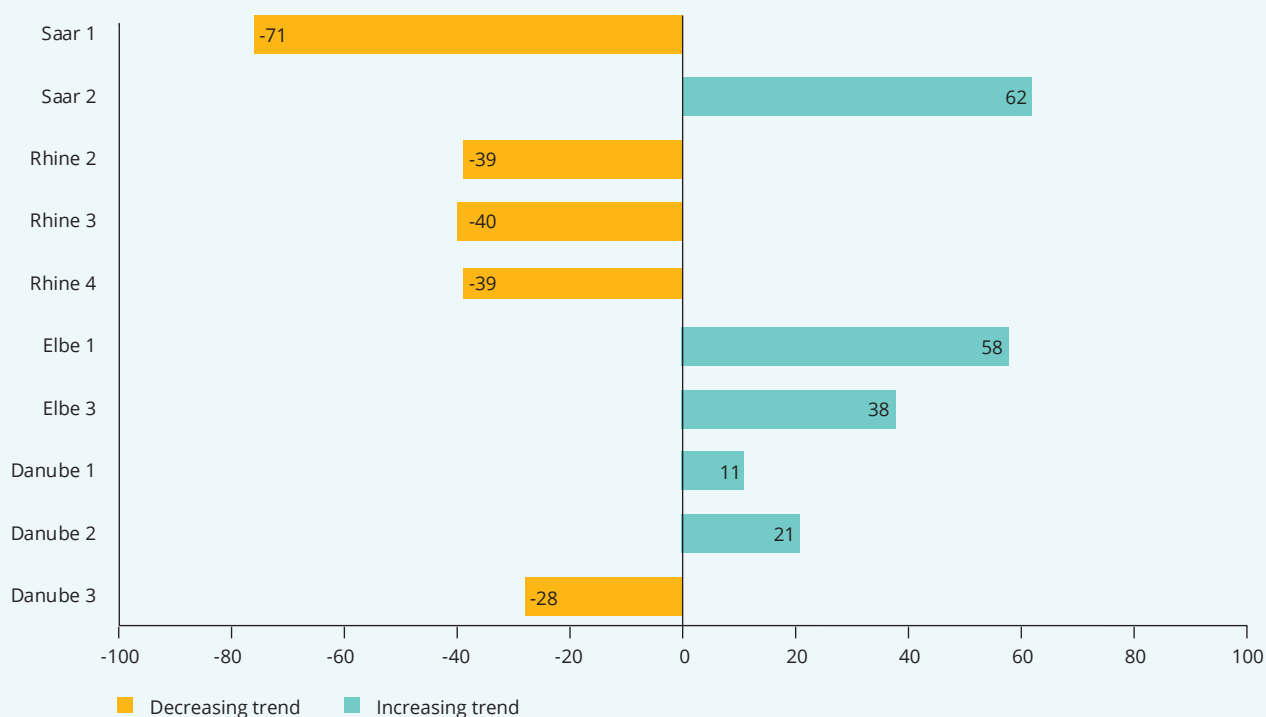

Source: Fliedner et al., 2016.

decaBDE in 2017 (see Section 1.4). The European Food Safety Authority (EFSA) issued scientific opinions on brominated flame retardants in the food chain between 2010 and 2012. Thus, regulatory action began relatively rapidly, reflecting the improved understanding of harmful chemicals in the environment and legislative means to act.

The information available on emissions and pressures reported by countries suggest that it is not clear how pBDEs are reaching the aquatic environment. The widespread contamination reported by Sweden was attributed to atmospheric deposition. Pathways to soil and water, through waste disposal and washing (which allows pBDEs to enter the sewers and hence UWWTPs), show that most pBDEs bind to solid matter (North, 2004; Anderson and MacRae, 2006; Zhang et al., 2017). Other researchers report a significant atmospheric transport role (Ricklund et al., 2010; Earnshaw et al., 2013), although brominated flame retardants were not associated with emissions of soot or small particles (Egeback et al., 2012).

Outlook

One of the striking features about pBDEs is the apparent mismatch between WFD status and emissions reporting. Most Member States reported no emissions of pBDEs under the E-PRTR or WISE, with only four Member States reporting some emissions under the WFD inventory.

While the large number of surface water bodies failing to achieve good chemical status owing to pBDEs can currently be attributed to Sweden, it seems likely that more Member States will report failing chemical status for pBDEs in the future. This is because of a change in the way in which the EQS is to be measured (from water to concentrations in biota). In the second cycle of RBMP reporting, Sweden applied this new EQS to its chemical status assessment and, in the future, so will other countries. Although many pBDEs have now been restricted, owing to their chemical behaviour and persistence, it seems likely that they will continue to cycle between biota and sediments for many years.

It is not clear if we fully understand the major transport pathways for pBDEs into the aquatic environment. We need to better understand the environmental pathways of pBDEs to identify potential measures for limiting further dispersal.

3.6 Contamination from metals and cyanide — mining and use

Metals have been used for centuries in many different applications. As well as leading to high concentrations in naturally metalliferous areas, their extraction and processing have led to polluted districts — even long after mines have closed down (Box 3.4). The widespread use of metals in industry, and their subsequent discharge into water, continue to cause pollution, as metals are transported within the water column and its sediments.

Table 3.1c List of pollutants most frequently exceeding EQSs in surface water bodies in the EU-25 (out of a total of 111 105 water bodies)

Pollutant	Type/use of chemical	Number of Member States with EQS exceedance	Number of water bodies with EQS exceedance ^(a)	Priority substance (PS)/RBSP ^(a)
Contamination from metals — mining and use ^(b)				
Cadmium	Metal	19	991	PS ^(c)
Nickel	Metal	18	600	PS
Lead	Metal	17	413	PS
Zinc	Metal	18	1 454	RBSP
Copper	Metal	16	808	RBSP
Arsenic	Metalloid	14	385	RBSP
Chromium	Metal	10	110	RBSP
Cyanide	Ion	8	72	RBSP

Notes: ^(a) Under the WFD, EU-wide standards apply for priority substances, while national or river basin standards apply for RBSPs.

^(b) Another six chemical elements exceeded standards for RBSPs in at least four Member States (barium, selenium, boron, cobalt, uranium and thallium) plus PCBs.

^(c) Defined as priority hazardous substances, for which all discharges, emissions and losses must be ceased.

Box 3.4 Ancient mining in the Harz Mountains in Germany

Metals such as lead and cadmium exceed the EQS in the Harz Mountains foothills of Weser River in northern Germany. For centuries, this was one of the most important ore mining regions in Germany. The mining activity mainly closed down in the 1930s and, in 1992, the last mine closed. Around the mines are a large number of tips, chemical and metal industries. The most contaminated rivers are some of the tributaries of the Leine River, which has a catchment area of about 6 500 km². Metal contamination down river is visible until the estuary of the Weser in the North Sea.

The river and floodplain sediments have been contaminated with waste and mine water over centuries. In the floodplains, high lead and cadmium concentrations affect agriculture, both pasture and arable land, along the river floodplains. Only limited livestock farming and agriculture are possible. Owing to the large area affected, decontamination would be very difficult and lowering concentrations of the metals in the rivers requires long-term effort (FGG Weser, 2016). Similar contamination and effects on waters are seen all over Europe in old mining regions.

Map 3.3 Metal pollution in the Weser catchment area from mining in the Harz Mountains

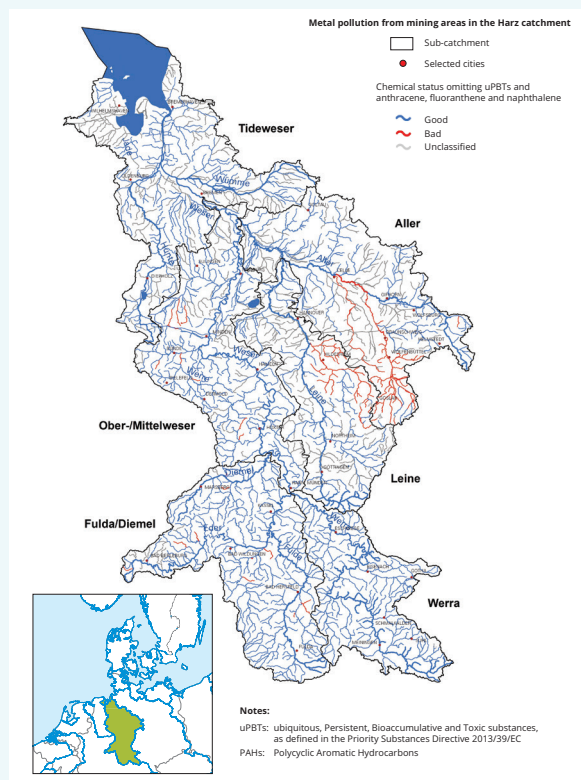

Source: FGG, Weser, 2016.

Sources and uses

Metals are natural substances and have been mined for centuries and used in many different ways, from producing tools, vehicles and buildings to sophisticated applications in industrial processes, as well as numerous domestic applications. Some historic uses have been shown to be particularly harmful, and so have been restricted, including the use of lead in water pipes and as a petrol additive. (Mercury is discussed in Section 3.4.)

Metals reach the aquatic environment in many ways, reflecting their multiple uses. Rainfall may leach metals from mines, industrial sites or waste sites or they may be discharged in effluents to sewers or directly into rivers, lakes, etc. For example, as well as UWWTP discharges, copper is emitted in significant quantities to water by thermal power stations and the aquaculture sector, and is one of the main biocidal active substances now being used in antifouling paints. Being natural elements, metals do not degrade, although they can be converted to other forms, which may be more or less harmful. Many dissolved metals can bind to suspended material and sediment and be transported downstream, or recycled within a water body.

Toxicity and EQS

Since metals occur naturally in the environment and some metals are essential elements for living beings, it is not always easy to assess when concentrations start having negative or even toxic effects. These can vary for individual species and environmental conditions.

The solubility and bioavailability of metals are influenced by calcium, pH and organic compounds naturally present in water (such as humic substances). Ecotoxicological effects are exacerbated in soft water (i.e. low lime content) and low pH. Improvements in our knowledge about the detrimental impacts of metals have led to extensive monitoring and research into ecotoxicological effects. Modelling of metals under such differing conditions has been undertaken to assess their bioavailability, allowing assessment of measured concentrations with the bioavailable concentration. This can be used to target measures where the metals present most risk to aquatic organisms. The 2013 Priority Substances Directive included bioavailable EQSs for nickel and lead, calculated using computer models.

The EQSs for cadmium, lead and nickel are set to protect aquatic ecosystems. The most sensitive species for cadmium and lead are invertebrates, while those for nickel include molluscs, crustaceans and vascular plants.

WFD status

Among the 15 priority substances most frequently causing failures to achieve good chemical status are the metals mercury (discussed in Section 3.4), cadmium, lead and nickel. This may reflect a relatively high level of reporting for metals, with approximately two-thirds of all Member States reporting failures to achieve chemical status for these substances. An additional five metals — zinc, copper, arsenic, chromium and cobalt — are among the most frequently reported RBSPs causing failures of ecological status. There were more failures in surface water bodies for zinc and copper than for many of the priority substances.

Despite widespread use, failures to achieve good chemical status for cadmium, lead and nickel range from 413 to 991 surface water bodies across the EU (Table 3.1c). Member States are making progress, with 943 water bodies improving in status for these metals since the first cycle of RBMP reporting, although 2 137 water bodies are still failing (EEA, 2018a).

Emissions

Figures 3.9-3.11 give an overview of the loads reported under different mechanisms.

For other metals, there are limited, comparable, emissions data, as the WFD inventory includes only priority substances. Further information on the E-PRTR reported emissions of zinc and copper are available (EEA, 2018c; Roovaart, et al., 2017).

There is a high level of reporting of emissions of metals from industry and UWWTPs. UWWTPs discharge the largest reported amounts of cadmium and nickel into water, while, for lead, industry also contributes a significant proportion. However, Roovaart et al. (2013a) suggested that there was significant under-reporting for emissions from UWWTPs for all three metals. Substantial releases into the air were from the processing and production of metals (cadmium and lead) and from the energy sector (nickel). Reflecting the widespread use of metals, countries reported a range of diffuse sources from agriculture, atmospheric deposition, unconnected households, stormwater overflows, transport and run-off.

However, despite high levels of reporting of metals emissions, the overall trend is not clear, with high variability from year to year.

Between 2007 and 2014, arsenic and copper emissions reported under the E-PRTR for industry, excluding UWWTPs, showed no clear trend, while there was a decrease in zinc emissions (Roovaart et al., 2017).

Figure 3.9 Existing emissions data for cadmium (tonnes per year)

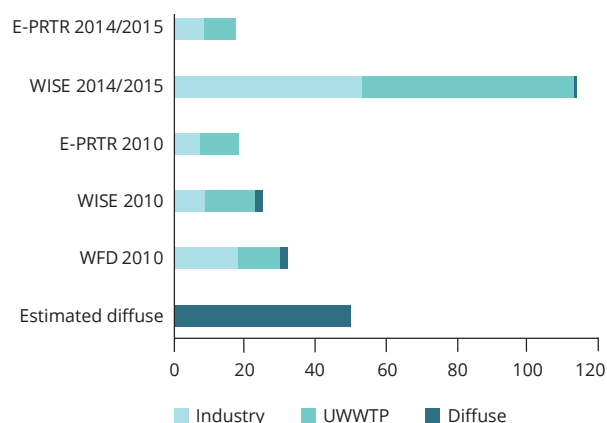

Figure 3.10 Existing emissions data for nickel (tonnes per year)

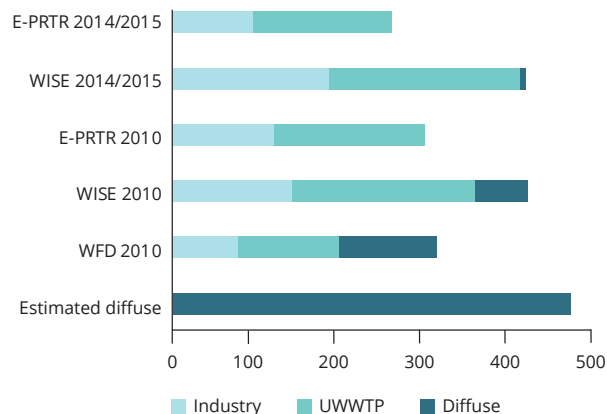
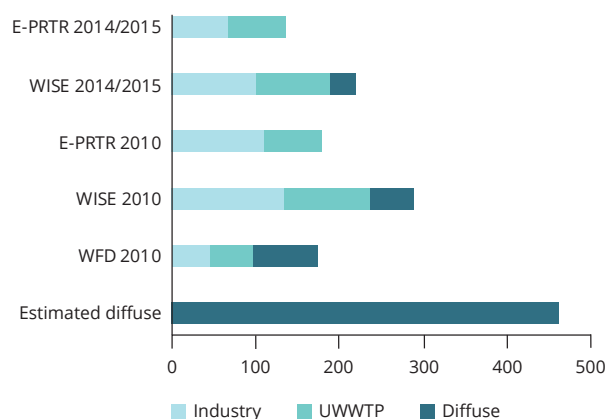

Figure 3.11 Existing emissions data for lead (tonnes per year)



Note: Loads given in these figures cannot be summed, as there may be double counting.

For UWWTPs reporting under the E-PRTR, there was a slight increase in copper and zinc emissions into water, with a large increase in reported arsenic emissions from one country.

Outlook

Regulation of, and research into, the behaviour of cadmium, lead and nickel in the aquatic environment has been undertaken for decades. While there are still a significant number of surface water bodies failing to achieve good chemical status for metals, there are promising signs that further improvements can be made.

Potential forthcoming challenges include the behaviour of metals as 'co-contaminants', where their presence at low levels may exacerbate the toxicity of other chemicals present in the same water body (Chapter 2).

3.7 Contamination from agriculture

The aim of pesticides is to have a harmful effect at the point of use, protecting crops and ensuring food security. However, owing to direct application into the environment, effects on organisms can occur beyond the intended target.

'Pesticides' is a broad term, including not only plant protection products, but also biocides such

as insecticides, disinfectants and fungicides. Data reflecting actual emissions of pesticides are often few, despite widespread use. This partly reflects many diffuse sources, for which reporting is in any case weak, and also owes to the way that water pesticides legislation affects reporting at the European level (Box 3.5). For this reason, trends in pesticide sales have been taken as a proxy for emissions, although this must be seen as indicative and provides little geographic information.

EU sales statistics were relatively stable between 2011 and 2014, with 360 000-400 000 tonnes sold per year (Eurostat, 2018). The group with the highest sales were fungicides and bactericides (about 43 %), followed by herbicides (35 %) and insecticides (5 %).

This section starts with insecticides, then considers herbicides. Fungicides and bactericides are not ranked highly in the lists of most frequently reported pesticides (Table 3.1d).

3.7.1 Insecticides

Ten Member States reported that HCH exceeded the EQS (Table 3.1d). Two other insecticides — parathion and malathion, regulated as RBSPs — were reported by four Member States. Otherwise no other insecticides were reported as causing failure in four or more Member States.

Table 3.1d List of pollutants most frequently exceeding EQSs in surface water bodies in the EU-25 (out of a total of 111 105 water bodies)

Pollutant	Type/use of chemical	Number of Member States with EQS exceedance	Number of water bodies with EQS exceedance ^(a)	Priority substance (PS)/RBSP ^(a)
Contamination mainly from agriculture (Section 3.7)				
HCH	Insecticide	10	104	PS ^(b)
Isoproturon	Herbicide, biocide	7	198	PS
MCPA	Herbicide	6	159	RBSP
Metolachlor	Herbicide	6	139	RBSP
Terbuthylazine	Herbicide	6	51	RBSP
2-4 D	Herbicide	4	18	RBSP
Malathion	Insecticide	4	13	RBSP
Parathion	Insecticide	4	7	RBSP

Notes: ^(a) Under the WFD, EU-wide standards apply for priority substances, while national or river basin standards apply for RBSPs. ^(b) Defined as priority hazardous substances, for which all discharges, emissions and losses must be ceased.

Hexachlorocyclohexane

Sources and uses

In the priority substances list, HCH represents a group of several similar molecules. Lindane (gamma-HCH) is the most well-known substance in the group. It was extensively produced in the EU from the 1950s onwards and was used as a broad-spectrum insecticide until the 1970s-1990s. Production led to large amounts of HCH-contaminated waste. Production sites were located near rivers and so there are many HCH-contaminated spots beside rivers (e.g. Sabiñánigo and Vitoria sites next to the Ebro river).

HCH is relatively persistent in the environment, is highly volatile and can be transported over long distances through natural processes. It has been listed under the Stockholm Convention since 2009.

Toxicity and EQS

HCH is carcinogenic, persistent, toxic and can bioaccumulate in food chains. The aim of the EQS is to protect top predators such as otters and cormorants, which are at risk owing to bioaccumulation.

WFD status

Despite restrictions on use for several years, HCH caused failures in 10 countries and over 100 surface water bodies. This reflects the persistence of the substance and some continued use. However, despite its volatility, in contrast with mercury it is not reported as causing many failures in northern countries.

Emissions

Figure 3.12 gives an overview of the different reported loads. Only a few Member States report loads of HCH from industry and UWWTPs and there is inconsistency between reports. Those reported under the E-PRTR suggest a decreasing trend, but are skewed by high loads in the chemical industry and energy sector reported by a single country, even though many uses have been restricted. There was very limited reporting on diffuse sources such as atmospheric deposition and stormwater overflows.

No overview of the total emissions into water in Europe can be made, because only a few Member States have reported emissions. It is unclear whether this is because of low emissions or because of low levels of reporting.

Figure 3.12 Existing emissions data for HCH (tonnes per year) (*)

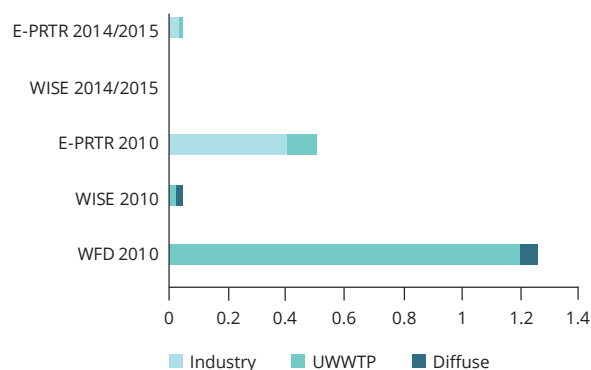

Notes: Loads given in these figures cannot be summed, as there may be double counting.

(*), CAUTION — low confidence in data, as there has been limited reporting of this substance (see Table 3.2). Details on the emissions data are given in Annex 1.

Outlook

Restrictions on the use of HCH suggest that, over time, failures to achieve good chemical status owing to this insecticide should decrease.

Parathion and malathion

Both parathion and malathion are organophosphorus compounds and inhibit acetylcholine esterase (AChE; further description in Table 2.3). Studies with the plankton *Daphnia* showed that long-term exposure to low concentrations was harmful (UBA, 2011).

Parathion and malathion are regulated as RBSPs by several Member States and exceeded the EQS in only a few water bodies.

No reliable figures on emissions of parathion and malathion are available.

3.7.2 Herbicides

Isoproturon

Sources and uses

From the 1990s, isoproturon was one of the most commonly used herbicides in Europe; it was used to control annual grasses and broad-leaved weeds, for example in cereals. However, because of its toxicity and persistence, approval was withdrawn in 2016 and sales were forbidden from March 2017 (EU, 2016). However,

Box 3.5 Where are pesticides in the RBMP reporting?

Pesticides do not appear as a significant cause for water bodies to fail to achieve good (chemical) status, despite expert views that pesticides — substances designed to eliminate part of an ecosystem — should be of concern. Why do we not see this in the data?

The figure below shows the numbers of water bodies in which pesticides have caused a failure to achieve good status, including both surface waters (out of 111 105 surface water bodies) and groundwaters (out of 13 411 groundwater bodies).

Number of water bodies failing

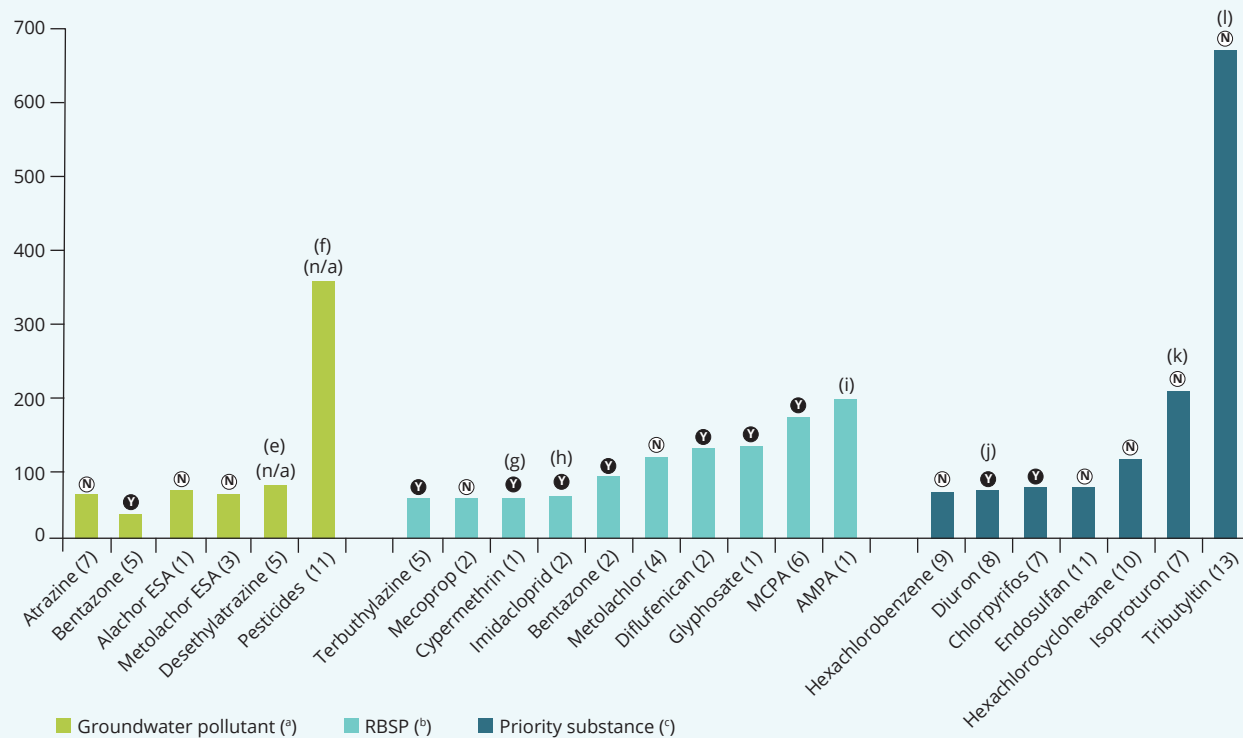

Restriction as pesticide in 2018 (d): (Y), approved; (N), not approved; n/a, not applicable.

Notes: The numbers in parentheses are the number of Member States reporting failures owing to that substance; n/a, not applicable.

(a) The groundwater pollutants shown are those for which at least 25 000 km² groundwater bodies failed to achieve good chemical status for that pesticide: [Groundwater bodies: Pollutants](#).

(b) The RBSPs shown are those for which at least 50 surface water bodies failed to achieve good chemical status for that pesticide: [Surface water bodies: River basin specific pollutants](#).

(c) The priority substances shown are those for which at least 50 surface water bodies failed to achieve good chemical status for that pesticide: [Surface water bodies: Priority Substances](#).

(d) EU pesticides database (EC, 2018a).

(e) Atrazine breakdown product.

(f) Active substances in pesticides, including metabolites, where the concentration of any individual exceeds 0.1 µg/l or the sum of the total measured exceeds 0.5 µg/l.

(g) Cypermethrin is approved as a pesticide and a biocide.

(h) Imidacloprid is approved as a pesticide but use has been heavily restricted since 2013; it has been approved as a biocide until July 2023 (EC, 2018b).

(i) AMPA is a breakdown product of glyphosate.

(j) Diuron is approved as a pesticide and approved but under review as a biocide.

(k) Isoproturon is not approved as a pesticide and approved but under review as a biocide.

(l) Tributyltin is a biocide that was mainly used to combat marine biofouling.

Box 3.5 Where are pesticides in the RBMP reporting? (cont.)

Why do we see this relatively low failure rate owing to pesticides? The following are some possible reasons:

- Restrictions and changes in practice have been enacted on many of the substances, these controls have been effective and concentrations in water have therefore decreased.
- Restrictions mean that the monitored substances do not reflect those actually in use, so that monitoring misses important information.
- Monitoring frequency (typically up to 12 times per year) in small rivers misses the short time in the growing season when a pesticide typically enters surface waters after use. Biocides can be emitted to surface waters throughout the year, from households, stormwaters or snow melt waters.
- WFD monitoring takes place in large water bodies, rather than small streams.
- Averaging concentrations over a year means that threshold standards for chronic exposure are not exceeded.
- Differences in uses of pesticides across the EU mean that, for any particular pesticide, there are relatively few records, which means that apparent significance at the EU scale is smaller than for other substances.
- National EQS or threshold values vary, so it is difficult to get a comparable picture.

From the RBMP assessments, we could conclude that:

1. reporting is correct — concerns about pesticides are overstated and measures have been effective;
2. reporting is correct for reported substances, but we lack information on many other pesticides; or
3. reporting of water bodies' status is inaccurate, owing to monitoring not reflecting the situation during peak periods of pesticide use.

But, from the reporting, we cannot be sure which of these apply.



isoproturon is still permitted for use as a biocide, so it may therefore enter surface waters via waste water or stormwater.

Toxicity and EQS

The EQS was set to protect sensitive marine species, especially algae (CIS WFD, 2005). Isoproturon is one of several herbicides that affect photosynthesis.

WFD status

Isoproturon was reported as failing in nearly 200 surface water bodies, the majority in western Europe.

Emissions

Figure 3.13 gives an overview of the different reported loads.

Only a few Member States reported loads from industry and UWWTPs. Loads reported in the WFD by two Member States indicate limited loads from industry (presumably related to production), but significant loads via UWWTPs. It is unclear how these arise. Diffuse sources reported by five Member States indicate high loads from agriculture and run-off, with minor loads from stormwater overflows.

No overview of the total emissions of isoproturon into water in Europe can be made, owing to reporting by only a few Member States. It is unclear whether this

Figure 3.13 Existing emissions data for isoproturon (tonnes per year) (*)

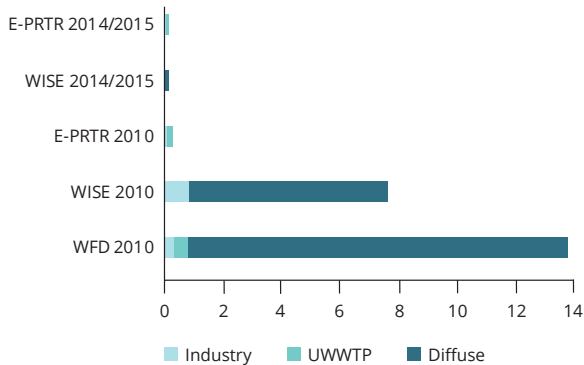

Notes: Loads given in these figures cannot be summed, as there may be double counting.

(*), CAUTION — low confidence in data, as there has been limited reporting of this substance (see Table 3.2). Details on the emissions data are given in Annex 1.

Box 3.6 Effects of pesticides in an intensive agriculture area

Map 3.4 shows assessment of the macroinvertebrate status in the German federal state Schleswig-Holstein using the 'Species at Risk — 'SPEAR' ' index, which links pesticide contamination to the composition of invertebrate communities (Liess and von der Ohe, 2005, Knillman, et al., 2018). For example, while insecticides may kill nearly all organisms in the short term, eggs might survive. In this case, species that reproduce several times a year have an advantage over species that reproduce only once per year or less. The SPEAR index shows the disappearance of the more sensitive species.

Streams may be sampled for chemical analysis once a month, with pesticides seldom being found, even during the application period. However, when samples are taken from small streams automatically, during heavy rainfall events just after application, or as composite samples over time, pesticides are found much more often. Until now, such sampling was made in scientific studies only (e.g. Liess et al., 1999; Moschet et al., 2014; Doppler et al., 2017; Langner et al., 2017; Gustavsson et al., 2017; Shardlow, 2017).

Map 3.4 shows that nearly all water bodies in Schleswig-Holstein are affected by pesticides. In relation to the three possible conclusions of Box 3.5, here (3) seems to apply: reporting of water bodies' status is inaccurate, owing to monitoring not reflecting the situation during peak periods of pesticide use.

Map 3.4 SPEAR index of streams in Schleswig-Holstein, showing the impact of pesticide pollution

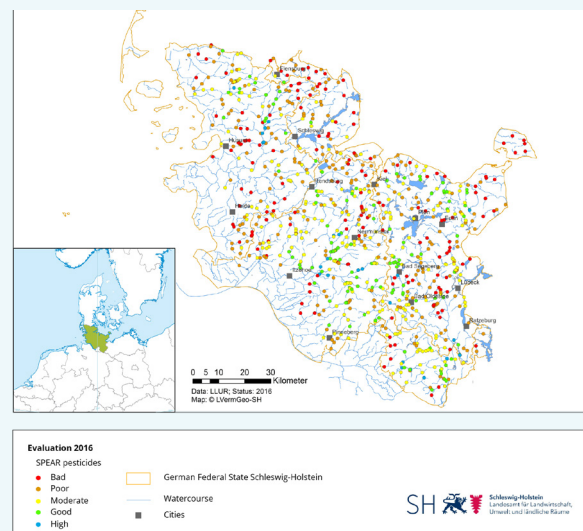

situation arises because of low emissions or because of low levels of reporting.

Outlook

Restrictions on the use of isoproturon as a pesticide had yet to come into effect in the period during which emissions and water body status information were being collected. Meanwhile, its continued approval for use as a biocide means discharges are likely to continue. As there are limited emissions data available, it seems unlikely that information in the near future will be able to show any changes.

MCPA, metolachlor, terbuthylazine and 2-4 D

Four other herbicides, regulated as RBSPs, were reported as exceeding their EQS by at least four Member States: MCPA, metolachlor, terbuthylazine and 2-4 D.

MCPA is a widely used herbicide that is used to control weeds in cereals and other crops. Its main effects in water are upon aquatic plants and algae, inhibiting photosynthesis and carbohydrate production, and it can be harmful to fish.

Metolachlor is a pre-emergence herbicide that inhibits the germination of grass species and so allows crops to grow better. EQSs are set to protect algae, as these are the most sensitive aquatic organisms.

Terbuthylazine is a systemic herbicide that is used to control grass and broad-leaved weeds and works as a herbicide by interfering with photosynthesis. Its major harmful effect in water is on invertebrates.

2-4 D is a selective herbicide that affects broad-leaved weeds. In water, algae are the most sensitive organism (Lewis et al., 2016; UBA, 2011, 2016).

MCPA and metolachlor both exceeded the national EQS in over 100 surface water bodies. Data on emissions into water are not available for these RBSPs.

Outlook

EU-wide restrictions on the use of pesticides should lead to improvements in surface water chemical status for these substances. With relatively few water bodies failing for pesticides, we may be seeing this in the data, but that interpretation should be treated with caution.

Most pesticides are not regulated under the WFD (Box 3.5) and so are not reported on at the EU level. Whole classes of pesticides — fungicides and bactericides — are missing. The substitution of heavily restricted pesticides with others that face less scrutiny in the water legislation means that we are missing information on other, comparably harmful, substances.

3.8 Contamination from navigation

Ships and boats, and the infrastructure to support them, can cause a range of environmental problems if poorly managed. For example, dredging channels can disturb buried contaminated sediments. This section focuses on a contaminant that is directly introduced into water by shipping activities.

3.8.1 Biocide: tributyltin

Sources and uses

Organisms such as algae and barnacles settle on wood, metal or plastic surfaces a short time after the material has been put in the water. This is a natural colonisation process called 'fouling', which can degrade the material. On vessels it also slows the boat down,

Table 3.1e List of pollutants most frequently exceeding EQSs in surface water bodies in the EU-25 (out of a total of 111 105 water bodies)

Pollutant	Type/use of chemical	Number of Member States with EQS exceedance	Number of water bodies with EQS exceedance ^(a)	Priority substance (PS)/RBSP ^(a)
Contamination mainly from navigation				
Tributyltin-cation	Biocide	14	659	PS ^{(b), (c)}

Notes: ^(a) Under the WFD, EU-wide standards apply for priority substances, while national or river basin standards apply for RBSPs.

^(b) Defined as priority hazardous substances, for which all discharges, emissions and losses must be ceased.

^(c) Substance is a uPBT, as defined in the Priority Substances Directive.

leading to higher energy use. Biocides are therefore used to resist biofouling, which work by coating the vessel's hull with an antifouling coating, but the biocide is continuously leached the water. This can result in water contamination.

Owing to aquatic toxicity and persistence, the use of organotin compounds in antifouling coatings has been banned since 2008.

Tributyltin (TBT) has also been used in wood preservatives, silicone sealants, roof sheeting, textiles and diverse other coatings. The remaining production and use of TBT continues to result in emissions from industry and UWWTPs.

Toxicity and EQS

TBT compounds affect the endocrine (hormone) system of certain marine and freshwater molluscs at very low concentrations. This results in malformation of the reproductive system, which can lead to impairment or eventually a complete loss of the ability to reproduce. The severity of the malformation increases with higher TBT concentrations (CIS WFD, 2005). The EQS was derived to protect organisms in both freshwater and saltwater environments.

WFD status

TBT causes failure to achieve good chemical status in surface waters in over 650 water bodies (Table 3.1e). These are spread across Europe, mainly in western and southern countries. TBT is a uPBT under the WFD, owing to the difficulty in remediating contaminated areas.

Emissions

Figure 3.14 gives an overview of the different reported loads.

Only a few Member States reported loads from industry, UWWTPs and diffuse sources.

No overview of the total emissions into water in Europe can be made, because only a few Member States have reported emissions.

Figure 3.14 Existing emissions data for tributyltin (tonnes per year) (*)

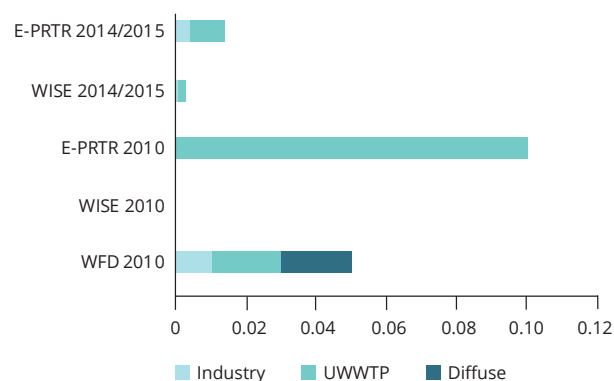

Notes: Loads given in this figure cannot be summed, as there may be double counting.

(*), CAUTION — low confidence in data, as there has been limited reporting of this substance (see Table 3.2). Details on the emissions data are given in Annex 1.

Outlook

Following the restriction on the use of TBT in boat antifouling, concentrations of TBT in water and sediments have decreased. Nevertheless, the EQS is still exceeded in places, which may relate to historic contamination, overpainted TBT layers, boat cleaning activities and uses other than for antifouling.

Other than removing TBT-contaminated sediments and efforts to remediate contaminated areas and buildings, there is little that can be done to remediate water bodies failing for this substance. Instead, careful management is required to allow contaminated material to be buried and to avoid re-disturbance.

Several biocidal active substances have been developed and established in efforts to substitute organotin compounds. The majority are based on copper or copper compounds (Section 3.6). For leisure craft, several non-chemical or non-biocidal alternatives have been established within the last decade.

Box 3.7 Despite restrictions, polluted sediments continue to have an impact on water quality

Shipyards in which TBT was used in antifouling coatings for boats led to a build-up of TBT in water and sediments over time. One example is the archipelago around Gothenburg, Sweden, and rivers and lakes in the river basin Västerhavet (Map 3.5). In the river basin, 13 water bodies do not have good chemical status owing to the exceedance of the TBT EQS. The restriction of TBT-based antifouling coatings stopped the increase of TBT concentrations in water. However, TBT can be released when sediment is transported in rivers or is dredged to allow access to ports and harbours.

Map 3.5 TBT causing pollution of harbours and leisure navigation areas: example from Sweden

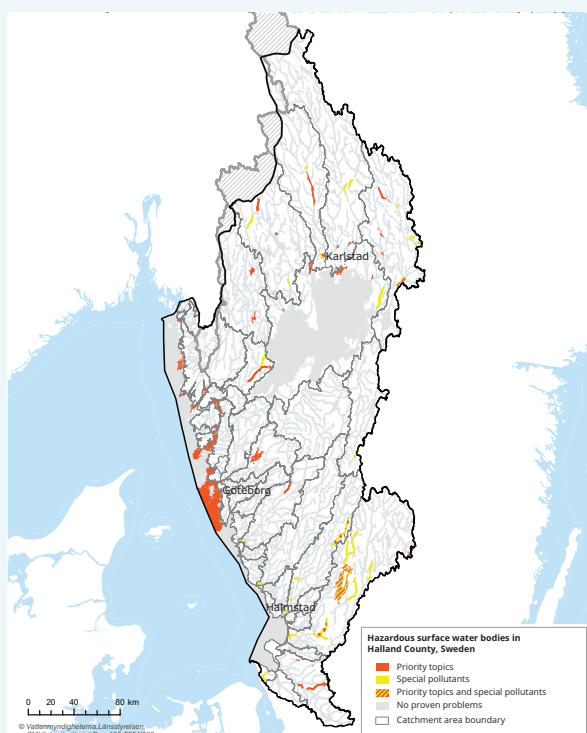

Source: Länsstyrelsen Kalmar län, 2016.

3.9 Summary

With the exception of mercury, pBDEs and some of the PAHs, Member States are making significant progress in tackling concentrations of individual priority substances in surface water bodies (EEA, 2018a). This should be seen as a success for European water and chemicals policies stretching back several decades.

Looking deeper, we can see some gaps in the data. Most priority substances have been regulated for many years, with monitoring, analysis and discharge permitting being well established. It is therefore perhaps surprising that, for many of the most frequently reported priority substances, there is a core set of 8-12 Member States reporting failures for those substances. It is unclear whether this accurately reflects pollution across the EU — namely that, in other countries, these priority substances are not a problem — or instead reflects the approach to monitoring and reporting. For instance, at least one country did not report any priority substances as causing failures to achieve good chemical status.

Similarly, at the EU level, comparable information on emissions is limited to only a few substances. Table 3.2 gives an overview of the number of Member States reporting in 2010 for the different source groups: industry, UWWTPs and diffuse sources. When different datasets are reported (the E-PRTR, the WISE or the WFD), the dataset with the highest number of Member States reporting is shown, i.e. 'the best case', summarising the information available on emissions of 15 priority substances. In the table, where emissions data are available for at least 14 countries, the cell is coloured green, indicating sufficient data availability. Between 7 and 14 countries, the cell is yellow, indicating moderate data availability. If data are available for fewer than seven countries, the cell is red.

Table 3.2 shows that there is rather limited emissions information available at the European level, even for well-characterised pollutants such as priority substances from point sources. Information on emissions from diffuse sources is poor: as point sources become better controlled, the significance of diffuse sources is getting higher.

Table 3.2 Number of Member States in which data are available for emissions of the 15 priority substances most frequently causing failure to achieve good chemical status

Pollutant	Source or pathway		
	Industry	UWWTP	Diffuse sources
Cadmium	24	22	8
Lead	26	22	9
Mercury	22	23	8
Nickel	26	26	9
Anthracene	9	9	7
Benzo(a)pyrene	7	4	5
Benzo(b)fluoranthene	5	2	3
Benzo(k)fluoranthene	5	2	3
Indeno(1,2,3-cd)-pyrene	5	2	3
Benzo(g,h,i)perylene	9	7	2
Fluoranthene	14	11	6
4-Nonylphenol	11	16	5
DEHP	14	17	5
pBDEs	3	3	4
Tributyltin-cation	5	3	2
Isoproturon	7	3	5
HCH	6	4	3

■ 14 or more Member States reporting ■ Between 7 and 14 Member States reporting ■ Fewer than 7 Member States reporting

Source: EEA, 2015, 2017b, 2018b.

These data gaps make it difficult to track progress in reducing emissions at the European level, as required by the WFD, and to assess the effectiveness of chemical source control legislation in protecting the environment.

One of the challenges with chemical status is that, once a persistent substance is in the aquatic environment, it can be there for a long time after emissions have ceased. This may lead to continued failure to meet good chemical status and a potential mismatch with the pressures. In the case of transboundary pollution, there is also a poor fit with the river basin approach promoted by the WFD, which works on the basis that management processes will influence local/regional water quality. In the case of persistent hazardous chemicals, particularly those that can be transported in the atmosphere, international chemicals legislation is also needed to underpin environmental protection. Evidence on the trend in emissions may be used to better inform the assessment of pressures.

Looking forwards to the next cycle of RBMP reporting, the EQS has been revised for some new priority substances and some existing priority substances to reflect updated scientific knowledge. It is likely that these changes will make the achievement of good chemical status in surface waters more challenging.

Specific actions proposed to improve the protection of waters:

- Further effort is needed to reduce emissions of mercury as a result of atmospheric emissions by the energy sector.
- Improved emissions reporting could help explain the main pressures causing PAHs to pollute surface waters, enabling the identification of more effective measures to tackle these pollutants.
- Improved understanding of the environmental pathways of pBDEs is needed to identify measures for limiting further dispersal.
- Improved monitoring and reporting of diffuse sources are needed, to ensure that the pressures are correctly understood and measures can be appropriately targeted.
- Streamlining of emissions reporting requirements, towards securing robust data satisfying all European emissions to water reporting requirements.

4 Strategies to reduce the chemical pollution of water

4.1 Introduction

A range of legislation exists to protect water from chemical pollution (see Section 1.3). At the EU level, the legislation both:

- protects against pollution in one country being transferred downstream to another; and
- ensures that similar minimum standards apply in Member States, avoiding unfair competition where weak standards give an advantage to polluters over others meeting more stringent standards.

The EU's Seventh Environment Action Programme (EU, 2013b) mandated the European Commission to develop 'a Union strategy for a non-toxic environment that is conducive to innovation and the development of sustainable substitutes including non-chemical solutions'. Alongside this, the EU action plan for a circular economy contains measures covering the whole product cycle: from production and consumption to waste management and the market for secondary raw materials (EC, 2015). Seen in this light, harmful chemicals used in products can present a barrier to materials being recycled. Finding new ways to deliver the desired benefit represents an opportunity for innovation (Box 4.1).

A radical rethink of our existing approach to chemicals has followed, since with thousands of chemicals in daily use, it is not sustainable to regulate a chemical then measure it in the environment and assess whether or not it is causing harm. Recognising that hazardous chemicals have already been released to the environment, we need to manage that situation over the next few decades, until such point as a more sustainable approach is in place (Box 4.2). The following sections describe some EU and national approaches to limiting the harm presented by chemical pollution.



Box 4.1 Chemical innovation for sustainability

Sweden has recently established a Chemical Substitution Centre at the state-owned RISE Research Institutes of Sweden to help small companies replace hazardous chemicals. The Centre aims both to stimulate the development of sustainable chemical products, production processes, articles and non-chemical methods and to build capacity in the public and private sector. This will contribute to developing greener products and a circular economy.

One example is to find and implement better alternatives for the problematic highly fluorinated compounds, such as per- and polyfluoroalkyl substances (PFAS), in consumer goods such as textiles, cosmetics and food packaging.

Note: Website under development as of 4 December 2018

Source: www.substitutionscentrum.se

Box 4.2 Chemicals for a sustainable future

The regulation of chemicals is entering a new phase as our understanding of the diversity and persistence of substances in the environment improves. The key issues in regulation are as follows:

- Chemical production is increasing and poses risks to ecosystems and human health.
- European legislation has reduced acute pollution, but chronic, less apparent, effects persist.
- Environmental and societal megatrends are changing exposure patterns.
- Chemical risks are traditionally underestimated by science.
- A focus on critical parameters is more important than gathering more general data.
- Monitoring for a wider variety of chemicals can provide earlier warnings.
- Policy approaches need to be further integrated in support of sustainability objectives.
- Avoiding upstream use of persistent and hazardous chemicals is key.
- A less toxic environment requires visionary and inclusive stakeholder approaches.

Source: EEA, 2018g.

4.2 EU strategic approach to pharmaceuticals in the environment

The 2013 Priority Substances Directive required the European Commission to develop a strategic approach to the pollution of water by pharmaceutical substances, with an expectation that the strategy would be developed by 2015. (The strategic approach was scheduled for adoption by the European Commission in 2018, but at the time of writing no date for adoption has been set.) Cutting across both health and environment legislative policies, pharmaceuticals in the environment is a 'headline grabbing' topic in which balancing the needs of different stakeholders is challenging yet essential. Building understanding and developing effective, proportionate, actions across different areas requires resources and high-level commitment. While the EU level approach is being developed, Member States continue to develop actions relevant to their competence.

4.2.1 The issue

Pharmaceuticals are used to improve the health of both humans and animals. Once taken, the medicine and its breakdown products ('metabolites') are excreted in urine and faeces. Where there is urban waste water treatment, sewage is treated and the medicine and its metabolites may be broken down further. The remaining substances may then be discharged into the environment, in effluent or as sewage sludge applied to the land.

The regulation of EU medical products (EU, 2004) requires environmental risk assessment for human and veterinary medicines. However, environmental risks are taken into account only within the risk-benefit analyses for veterinary medicines. This, in part, reflects the tensions in priorities between the benefits of health care and the risks to water resources and ecosystems. As understanding of the potential effects

of very low levels of pollutants has increased, so has concern about the release of biologically active molecules into the environment.

Recently, interest has been rising in the role that the environment may have in the transmission of antimicrobial resistance (UNEP, 2017). This relates both to concentrations of antibiotics and to resistant bacteria. Strategies such as the World Health Organization's 'One Health' programme are likely to lead to further activities in the future (WHO, 2018).

4.2.2 Member State responses

There was collaboration between Member States and the European Commission well in advance of the Priority Substances Directive (EU, 2013a). Two-way communication — advising of concerns and learning about them — is part of a well-functioning,

high-level process. Possible EQS values were prepared and, although these did not become legally binding, they are used to indicate whether or not there may be concentrations of concern.

To differing extents, Member States were investigating concentrations of medicines in their surface waters. For example, further to investigations into the effects of a contraceptive pill ingredient, EE2, on fish, work in the United Kingdom considered waste water treatment and socio-economic impacts of pharmaceuticals in the environment (Environment Agency, 2008; Gardner et al., 2013; Defra, 2015). In Germany, between 2013 and 2015, concentrations of several pharmaceuticals were compared with possible EQSs, revealing isolated cases in which EQSs were exceeded for carbamazepine (an anti epileptic), clarithromycin, the contraceptives E2 and EE2 and, more frequently, diclofenac and ibuprofen (Figure 4.1).

Figure 4.1 Pharmaceuticals in German surface waters: a comparison of annual concentration means at surveillance monitoring sites with possible EQSs

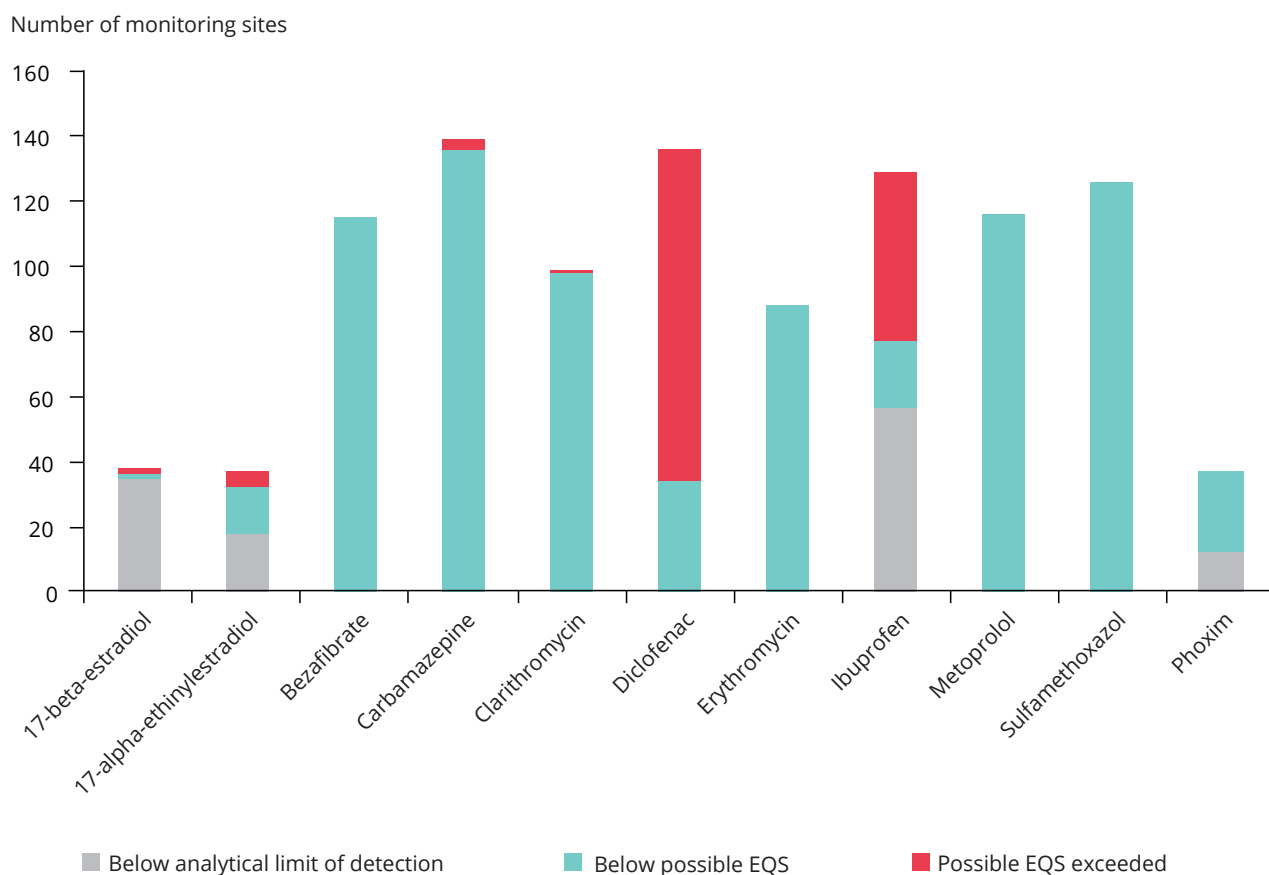

Source: UBA, 2017a.

4.3 National Action Plans to reduce the risks posed by pesticides

EU legislation requires Member States to derive national approaches where this is appropriate. For example, the Sustainable Pesticide Use Directive (EU, 2009b) required that Member States introduce National Action Plans, setting objectives, measures and timelines to reduce the risks to human health and the environment by the end of 2012, including:

- training users, advisors and distributors;
- inspecting pesticide application equipment;
- prohibiting aerial spraying;
- protecting the aquatic environment and drinking water;
- limiting pesticide use in sensitive areas;
- providing information and awareness raising about pesticide risks;
- developing systems for gathering information on pesticide acute poisoning incidents, as well as chronic poisoning developments, where available.

This has led to measures within countries that meet national needs. For example, the National Action Plan in Ireland (DAFM, 2013) includes objectives that aim to improve the accessibility of information for the general public and amateur users, including helping them to make decisions appropriate to their garden, with due consideration to neighbours, non-target organisms and the environment.

4.4 National action programmes for combating risks posed by micropollutants

To protect their citizens and the environment, some Member States have initiated national programmes and strategies to reduce the risks posed by substances harmful at low concentrations ('micropollutants'). The following are examples of such programmes:

- The Swedish MistraPharma Project 2008-15 worked to identify human pharmaceuticals that are likely to be of concern to aquatic ecosystems

and addressed the risk of promoting antibiotic resistance in the environment (<http://www.mistrapharma.se>). It also proposed risk management strategies, in particular the improvement of regulatory test requirements and waste water treatment technologies.

- In France, a comprehensive monitoring programme was established on micropollutants, namely the 'National plan against micropollutants 2016-2021' (Ministère de la Transition écologique et solidaire, 2016). It aims to reduce micropollutant emissions to protect and preserve water quality and biodiversity.
- In Britain, United Kingdom Water Industry Research (UKWIR) managed the Chemicals Investigation Programme, as a response to current and emerging legislation on trace substances in the aquatic environment, bringing together water and waste water companies in England, Wales and Scotland with regulators (Gardner et al., 2012, 2014). Phase 1 (2010-2014) of the Chemicals Investigation Programme involved obtaining a comprehensive overview of the concentrations in effluents of over 70 contaminants and found that the principal source of many trace contaminants was domestic. The second phase, from 2015 to 2019, comprises sampling of 74 substances at over 600 sewage treatment plants. Substances of interest include metals, industrial chemicals such as fire retardants and biocides, hydrocarbons, pharmaceuticals, hormones and personal care products. The research programme has examined several novel waste water treatment techniques that can be used to supplement existing processes.
- The German Trace Substance Strategy is being developed on the basis of multi-stakeholder dialogue, with stakeholders from industry, environmental non-governmental organisations, associations of municipal companies, drinking water suppliers, operators of waste water treatment plants, federal government departments, public authorities and Federal State representatives. The strategy's purpose is to prevent and reduce inputs of trace substances from biocides, human and veterinary pharmaceuticals, plant protectants, industrial chemicals, detergents and personal care products into the aquatic environment. Guided by the

precautionary principle and the polluter pays principle, both of which are enshrined in EU and German law, the stakeholders have developed recommendations for measures at the source, both on the user side and at the end of pipe (UBA, 2017b).

- The Pharmaceutical Chain Approach is a Dutch strategy that considered the life cycle of pharmaceuticals, including development, authorisation, prescription, use and waste water treatment. End of pipe measures, e.g. waste water treatment, are seen as complementary to measures in the health sector. With a focus on pharmaceuticals, a set of programmes was initiated in the Netherlands, including a programme on medicines out of waters, public communication strategies on the reduction of antibiotic use and a programme on the substitution of certain drugs by others that are less harmful to the environment (Grinten et al., 2016) ⁽¹¹⁾.

4.5 Summary

Regulation to protect water quality is key to protecting public health and the environment. Many approaches are possible — the challenge now is perhaps to ensure that there is coherence between different activities. While the WFD greatly facilitates coherence in water management, activities regarding chemicals may not be so well aligned. For instance, efforts to reduce air pollution may lead to discharges into water when pollutants are filtered out of gaseous emissions.

It should be understood that the cycling of chemicals 'from cradle to grave' can lead to water pollution if not adequately managed. Long-term strategies towards a circular economy and a non-toxic environment hold the promise of ceasing chemical pollution in future. However, for the medium term, practical approaches to preventing pollution by existing products and substances continue to be required.

⁽¹¹⁾ <https://www.daarwordtiedereenbetervan.nl> (accessed 26 March 2018) and <https://jamdots.nl/view/239/Medicijnresten-uit-water> (accessed 26 March 2018).

5 Conclusions

5.1 Introduction

Earlier chapters discussed various approaches tackling the significant concern that we are failing to adequately protect aquatic ecosystems from mixtures of low concentrations of chemicals, and reviewed information available for established water pollutants. Once released into the aquatic environment, persistent harmful chemicals are very difficult to control and may have long-lasting effects. We need effective ways to protect our water resources to ensure their long-term sustainability.

Two major challenges confront our understanding of chemicals in surface waters across Europe. The first is that, despite significant effort, we struggle to show that at the European level there have been improvements in the environment resulting from increased controls of the most well-known pollutants. The second is that chemical status under the WFD reflects scientific understanding that is at least 20 years old.

Headline chemical status is driven by the 'one out all out' approach of the WFD, where the status reflects that of the worst component. For chemicals, the pass/fail nature of the EQS means that the failure of one priority substance or one RBSP will lead to the water body failing to achieve good status. Although it is possible to see improvements in individual priority substances (EEA, 2018a), the revision of EQSs and the addition of new priority substances to reflect better understanding of chemical risks represent recurring challenges to achieving good chemical status. This difficulty is more than a 'communications issue'. Maintaining political support and resources towards improved environmental protection is difficult at every level, when little, no or even negative progress is made.

Given that standards change over time, there is a need to be able to communicate about progress made according to the standards when they were originally set. Equally, the WFD needs to reflect robust new scientific understanding that identifies new risks. This chapter reflects on the findings of earlier chapters and proposes some possible ways forward.

5.2 Conclusions on assessing the ecological impacts of chemical pollution

The chemical status of surface waters, reported under the WFD, provides an assessment of a very limited number of harmful chemicals in water bodies comparable across Europe. Much more detailed information on chemical contamination can be available at a more local scale. Through scientific efforts such as the application of novel methods of sampling and chemical enrichment (Schulze et al., 2017), the detection of several hundred organic chemicals in a single freshwater sample is becoming more common.

Currently, we lack causal links between the chemical status and ecological status of surface water bodies. This contrasts with the real situation, where organisms may be living in polluted water that is possibly affected by multiple pressures. Improvements in our understanding of how chemical mixtures can adversely affect organisms may be used to improve our understanding of the interlinkage between ecological status and chemical status. Applying the precautionary principle would imply that assessment include consideration of chemical mixtures, which can act along similar pathways in the organism. However, the potential consequences of the presence of multiple chemicals is not reflected in current lists of priority substances and RBSPs.

More generic solutions are needed to protect water from contamination by chemicals. Approaches that regulate concentrations in water on a substance-by-substance basis will not cope with large numbers of substances present at apparently low concentrations but which might, in combination, have ecological effects. Effect-based approaches offer a way to combine existing information on the presence and abundance of species in ecological monitoring, while improving our understanding of the links between chemical and ecological status. The flexible approach of the WFD allows Member States to use effects-based methods in a complementary way in water management, for example in investigative monitoring,



© Dennis Lisbjerg, Picture 2050/EEA

alongside surveillance and operational monitoring. The major obstacles to the use of such tools seem to be the mis-alignment with the chemical source control approach, which is aimed at single substances, and the lack of legal obligation. In the absence of legal requirements, one way to demonstrate the value of this approach would be to collect case studies showing that effect-based information has been used in a regulatory context for surface waters.

5.3 Data collection on chemicals in water at the EU level

Significant effort goes into reporting in the European system and then into making that information available. In the light of the management adage that 'if you can't measure it, you can't change it', we reviewed the information available for the key chemical pollutants.

5.3.1 Data on chemical status and priority substances

Monitoring obligations need to balance the costs of the resources needed to undertake monitoring with the value of the knowledge gained and the application of that knowledge. Collecting data that have no application not only is wasted effort, but may also mean that an opportunity is missed to gather information that would be used to inform measures.

What should be classified as a priority substance? A working basis for a 'European level pollutant' is provided by the prioritisation process, which considers a substance to be of European concern if it exceeds the proposed EQS in four or more Member States (JRC, 2016). Following reporting of the second cycle of the RBMP, the continuing relevance of a priority substance can be considered (Table 5.1).

Table 5.1 Priority substances that exceeded the EQS in fewer than 15 (out of 111 105) surface water bodies and four or fewer Member States

Priority substance	Type/use of chemical	Number of water bodies where good chemical status is not achieved	Number of Member States reporting that good chemical status is not achieved
Atrazine	Herbicide	9	4
Dichloromethane	Industrial	6	4
Chloroalkanes C10-13	Industrial	5	4
Tetrachloroethylene	De-greaser, dry cleaning	6	3
Chlorfenvinphos	Pesticide	5	3
Alachlor	Herbicide	5	3
Pentachlorophenol	Pesticide, disinfectant	3	3
Pentachlorobenzene	Industrial	7	2
Trichloroethylene	Industrial	4	2
Trichlorobenzenes	Industrial	3	2
Simazine	Herbicide	4	1
1,2-Dichloroethane	Industrial	1	1
Carbon tetrachloride	Refrigerant, firefighting	1	1

Note: Preliminary results based on the WISE-SoW database, including data from the EU-25.

Source: [Surface water bodies: Priority Substances](#), accessed 29 August 2018.

The very low numbers of water bodies failing for these substances suggest that, assuming monitoring and reporting are accurate, measures have been effective in preventing the entry of these chemicals into surface waters. This is a success for European water and chemicals policies.

With such low numbers of water bodies failing to achieve good chemical status for these substances, they may be candidates for delisting as priority substances, freeing up resources for the monitoring of substances now presenting more of a risk to the quality of European waters.

It is also possible to review RBSPs to identify those that might have European-wide relevance (Table 5.2). The RBSPs most often exceeding their EQSs are shown, with the range in EQS values used (derived from Member States' RBMP reporting).

Decisions on which substances are proposed as priority substances are made through the collaborative process under the WFD, prior to a European Commission proposal subject to the co-decision process. The most recent review considered thousands of chemicals, assessing spatial distribution, temporal frequency and the extent of the exceedances (JRC, 2016). It is currently unclear when the next revision to the list of priority substances may be made.

Guidelines for EQS derivation are set in the technical guidance document for environmental quality standards (EC, 2011b). Although such documents should promote coherence and harmonisation, EQS values can differ by up to 10 000 times for the same substance (e.g. vinylchloride) (Vorkamp and Sanderson, 2016).

As well as variation in values of EQSs, there can be significant differences in the numbers of RBSPs between Member States — countries reported between 1 and 136 RBSPs as causing failure in the second cycle of RBMP reporting. This has an influence on the likelihood of an RBSP failing to meet an EQS and thus on the likelihood of a water body being able to achieve good ecological status. More RBSPs make it more likely that a water body may not meet the EQS.

Looking forward, it would seem that improving consistency or harmonising RBSP EQS values would improve the comparability between river basin districts. However, it would not address the differing numbers of substances for which standards are set and, given the variation across Europe of substances meeting the RBSP definition, it seems that overcoming this issue would be difficult.

Consideration should also be given to including all chemicals information in one place (e.g. chemical

status), reflecting actual water management, if other ways are found to better integrate chemical and ecological status.

5.3.2 Emissions to water

Reporting known or estimated chemical emissions is a way to gather information on trends over time, without knowing what impact those emissions might have. Unfortunately, emissions data on priority substances as reported for the WFD, E-PRTR and WISE-SoE are only partially informative. The WFD dataset is difficult to interpret, with apparent errors, inconsistencies and missing river basin districts.

A lack of comparable information at the EU level on diffuse sources of pollution of water represents a potentially significant gap (Roovaart et al., 2013a, b).

Given these significant concerns, what can we see in the data?

Table 3.2 provided an overview of the number of Member States reporting emissions in 2010 for the different source groups: industry, UWWTPs and

diffuse sources. The metals cadmium, lead, mercury and nickel were widely reported, but, even for these long-regulated substances, there are difficulties with data reporting. While a range of diffuse sources were reported for metals, different approaches to calculation between the countries render those data incomparable.

For another set of pollutants, about half of the countries reported on a regular basis (some PAHs, 4-nonylphenol and DEHP). Although this allows for some overview at the European level, there were difficulties with the data from different reporting streams (the E-PRTR, the WFD and the WISE-SoE), making the interpretation of a trend difficult.

For a number of pollutants, only a few Member States reported loads (TBT, pBDEs, isoproturon and HCH). Therefore, no useful overview exists for these pollutants at the European level.

Diffuse sources of pollution have been reported by only a few countries, even though — where they are reported — they seem to constitute a large proportion of diffuse sources for almost all priority substances (Roovaart et al., 2017). This represents a significant data gap.

Table 5.2 Selected RBSPs with the largest numbers of countries reporting failures, with a comparison between the minimum and maximum national standards for annual average EQSs (inland waters)

Name of substance	Number of Member States with EQS exceedance	Number of water bodies with EQS exceedance	Minimum (µg/l)	Maximum (µg/l)	Median (µg/l)
Zinc ^(a)	18	1 454	3.1	1 000	34
Copper ^(a)	16	808	0.5	120	8
Arsenic	14	385	0.5	50	10
Chromium	10	110	0.6	50	5
Total cyanide	4	47	0.6	300	25
Free cyanide	5 ^(b)	25	1	50	5
MCPA	6	159	0.1	1.6	0.6
Metolachlor	6	139	0.1	1	0.2
Terbutylazine	6	51	0.2	1	0.5
2-4D	4	18	0.1	20	0.3
Malathion	4	13	0.0008	0.2	0.01
Parathion	4	7	0.0002	0.01	0.005

Notes: Data from RBMP reporting differ from those reported by Vorkamp and Sanderson (2016), which were derived from voluntary reporting.

^(a) The range of EQSs may reflect differences in bioavailability (e.g. owing to water bodies with different physico-chemical characteristics in terms of pH, hardness and dissolved organic carbon).

^(b) One country had standards for both free and total cyanide, hence the eight countries reported in Table 3.1.

Sources: [Surface water bodies: River basin specific pollutants](#), accessed 30 August 2018; [Surface water bodies: River basin specific pollutants reported as 'Other'](#), accessed 08 October 2018.

Ways forward:

- Currently, data on emissions are required under EU legislation for both the E-PRTR and the WFD and are voluntarily reported under the WISE-SoE. Improving emissions data so that they are collected under consistent and comparable approaches would provide clear information on the direction of travel for chemical pressures. This could be especially helpful for substances where the surface water chemical status assessed under the WFD is driven by historic rather than current emissions. Streamlining emissions reporting, towards securing robust data satisfying all European emissions to water reporting requirements, would facilitate improved data.
- As point sources of pollution are better controlled, the relative significance of diffuse sources increases. Our lack of knowledge about diffuse emissions represents an important information gap. Improvement in the monitoring and reporting of diffuse sources is needed to ensure that pressures are correctly understood and measures are appropriately targeted.

5.4 Conclusions on the effectiveness of source control legislation

Reported emissions data do not allow quantitative conclusions to be drawn about the effectiveness of source control measures taken in the past. The data are not sufficiently reliable and the time series are not long enough for analysis. However, emission loads should have decreased, driven by the implementation of the directives on Dangerous Substances (EU, 1976), Urban Waste Water (EU, 1991) and Industrial Emissions (EU, 2010). In addition, chemicals are now widely regulated and environmental concerns are frequently reflected in risk and hazard assessments (see Section 1.3).

Over recent decades, reductions in emissions from industry (particularly of regulated chemicals) have led to significant sources now being from domestic use (Gardner et al., 2014). Despite much tighter regulation, pesticide use in agriculture can still cause contamination. Events such as heavy rainfall can result in surface run-off, overload drainage systems and cause surges in the pollutant load into surface waters.

As a last chance to prevent releases into the environment, we rely on urban waste water treatment to reduce concentrations of the many pollutants in water that have been introduced further upstream. However, such treatment may not achieve sufficiently



low concentrations of micropollutants such as pharmaceuticals, ingredients of household chemicals, chemicals used in small businesses or industries and pesticides. Investigations into more advanced waste water treatment techniques for the elimination of micropollutants via a fourth treatment stage are being tested in several countries. Such techniques cost about EUR 0.1-0.15/m³ in large treatment plants, but they are not yet applied on a regular basis (UBA, 2018).

Table 5.1 gave examples of substances for which measures to prevent water pollution seem to have been effective. Sometimes, these measures involved totally banning the use of a substance; less drastic measures included restriction on use where losses of the substance to water might occur, either through more careful use of the substance (such as in good practice for pesticide application) or banning its use in certain applications because such measures are not possible.

In this report, the focus has been on priority substances that continue to present a risk to Europe's surface waters. Table 5.3 summarises the current situation and considers what more could be done to improve environmental protection.

Table 5.3 Effectiveness of controls to prevent chemicals reaching the aquatic environment from point sources

	Quality of emissions data (point sources) ^(a)	Natural sources as well as human	Number of water bodies failing to achieve good chemical status ^(b)	Historic ^(c) and/or current emissions	What more needs to be done to protect the environment
	Strong Moderate Weak	Yes No	Many Medium Low	Historic Current	
Contamination mainly through atmospheric deposition (section 3.4)					
Mercury ^(d)	Strong	No	Many	Current	Maintain efforts to cease emissions from human activities, e.g. coal burning.
Benzo(g,h,i)perylene + Indeno(1,2,3-cd)-pyrene	Moderate	No	Medium	Historic	
Fluoranthene	Moderate	No	Medium	Historic	Improve understanding of significant sources to water, improve efforts to reduce atmospheric emissions and reduce road run-off.
Benzo(a)pyrene	Weak	No	Medium	Historic	
Benzo(b)fluoranthene + Benzo(k)fluoranthene	Weak	No	Low	Historic	
Anthracene	Moderate	No	Low	Historic	
Contamination mainly from urban settlements (section 3.5)					
DEHP	Moderate	No	Low	Current	Prevent new uses and improve urban waste water treatment.
4-Nonylphenol	Strong	No	Low	Current	
pBDEs ^(e)	Weak	No	Many	Historic	Improve understanding of pathways to water and of waste management of furniture, etc., to prevent releases.
Contamination mainly from industry and mining (section 3.6)					
Cadmium	Strong	No	Low	Historic	Reduce atmospheric emissions, maintain efforts to minimise losses from industry and urban waste water treatment and provide treatment facilities and remediation at (old) mining areas.
Nickel	Strong	No	Low	Historic	
Lead	Strong	No	Low	Historic	
Contamination mainly from agriculture (section 3.7)					
HCH ^(d)	Weak	No	Low	Historic	Clean-up contaminated sites.
Isoproturon ^(e)	Weak	No	Low	Historic	Enforce new restriction.
Contamination mainly from navigation (section 3.8)					
Tributyltin-cation	Weak	No	Low	Historic	Ensure non-restricted uses do not cause releases to water.

Notes: Information on diffuse sources is mostly poor, so is excluded from this table.

^(a) See Table 3.2.

^(b) See Table 3.1: based on 111 105 water bodies and the number of water bodies failing for that substance ('many' refers to over 10 000, 'medium' refers to over 1 000 and 'low' refers to over 100).

^(c) 'Historic' refers to use before 1940.

^(d) International conventions such as the Minamata Convention on mercury and the Stockholm Convention on POPs (see Section 1.4).

^(e) Regulatory approval for isoproturon as a pesticide expired in 2017, so data reflect the period when its use was still permitted; it is still permitted for use as a biocide (although this is under review).

Conclusions

Moving beyond the well-established pollutants represented by priority substances, we need to implement methods that effectively assess the risk presented by mixtures in the aquatic environment.

Longer term sustainability can be achieved through the development of alternative approaches that deliver the desired function currently provided by harmful chemicals.

List of abbreviations

2-4 D	2,4-Dichlorophenoxyacetic acid
AChE	Acetylcholine esterase
AMPA	α -Amino-3-hydroxy-5-methyl-4-isoxazolepropionic acid (breakdown product of glyphosate)
BOD	Biological oxygen demand
BQE	Biological quality element (within the WFD assessment system)
CEN	Comité Européen de Normalisation
DEHP	Bis(2-ethylhexyl)phthalate
DDT	Dichlorodiphenyltrichloroethane
DPSIR	Drivers, pressures, state, impacts and responses
EEA	European Environment Agency
EFSA	European Food Safety Authority
EIA	Environmental impact assessment
E-PRTR	European Pollutant Release and Transfer Register
EQS	Environmental quality standard
EQSD	Environmental Quality Standards Directive
ETC-ICM	European Topic Centre on Inland, Coastal and Marine Waters
EU	European Union
EU-25	The 25 EU Member States that reported under the WFD to the EEA by February 2018 (i.e. the EU-28 except Greece, Ireland and Lithuania)
EU-28	The 28 EU Member States as of 1 July 2013
FP7	Seventh EU Framework Programme for Research and Technological Development
HCH	Hexachlorocyclohexane
ISO	International Organization for Standardization
JRC	Joint Research Centre

List of abbreviations

MCPA	2-Methyl-4-chlorophenoxyacetic acid
nAChR	Nicotinic acetylcholine receptor
NPE	Nonylphenol ethoxylates
PAH	Polycyclic aromatic hydrocarbon
pBDE	Polybrominated diphenylether
PCB	Polychlorinated biphenyl
POP	Persistent organic pollutant
PSII	Photosystem II
RBMP	River Basin Management Plan
RBSP	River basin specific pollutant
REACH	Registration, Evaluation, Authorisation and Restriction of Chemicals (EU Regulation)
TBT	Tributyltin
TEQ	Toxic equivalent
uPBT	Ubiquitous, persistent, bioaccumulative and toxic substances, as defined in the Priority Substances Directive (13/39/EU)
UWWTP	Urban waste water treatment plant
WFD	Water Framework Directive
WISE- SoE	Water Information System for Europe — State of the Environment

References

- Abdel-Shafy, H. and Mansour, M., 2016, 'A review on polycyclic aromatic hydrocarbons: source, environmental impact, effect on human health and remediation', *Egyptian Journal of Petroleum* 25(1), pp. 107-123.
- AbwV, 1997, 'Verordnung über Anforderungen an das Einleiten von Abwasser in Gewässer', *Abwasserverordnung* (<https://www.gesetze-im-internet.de/abww/AbwV.pdf>) accessed 3 September 2018.
- Altenburger, R., et al., 2015, 'Future water quality monitoring — adapting tools to deal with mixtures of pollutants in water resource management', *Science of the Total Environment* 512-513, pp. 540-551.
- Altenburger, R., et al., 2018, 'Mixture effects in samples of multiple contaminants — an inter-laboratory study with manifold bioassays', *Environment International*, 114, pp. 95-106.
- Anderson, T. d. and MacRae, J. D., 2006, 'Polybrominated diphenyl ethers in fish and wastewater samples from an area of the Penobscot River in Central Maine', *Chemosphere* 62(7), pp. 1153-1160.
- Baker, D. R. and Kasprzyk-Hordern, B., 2013, 'Spatial and temporal occurrence of pharmaceuticals and illicit drugs in the aqueous environment and during wastewater treatment: new developments', *Science of the Total Environment* 454-455, pp. 442-456.
- Beckers, L-M., et al., 2018, 'Characterization and risk assessment of seasonal and weather dynamics in organic pollutant mixtures from discharge of a separate sewer system', *Water Research* 135, pp. 122-133.
- Brack, W., et al., 2015, 'The SOLUTIONS project: challenges and responses for present and future emerging pollutants in land and water resources management', *Science of the Total Environment* 503-504, pp. 22-31.
- Brack, W., et al., 2016, 'Effect-directed analysis supporting monitoring of aquatic environments — an in-depth overview', *Science of the Total Environment* 544, pp. 1073-1118.
- Brack, W., et al., 2017, 'Towards the review of the European Union Water Framework Directive: recommendations for more efficient assessment and management of chemical contamination in European surface water resources', *Science of the Total Environment* 576, pp. 720-737.
- Busch, W., et al., 2016, 'Micropollutants in European rivers: a mode of action survey to support the development of effect-based tools for water monitoring', *Environmental Toxicology and Chemistry* 35, pp. 1887-1899.
- Carvalho, R. N., et al., 2014, 'Mixtures of chemical pollutants at European legislation safety concentrations: how safe are they?', *Toxicological Sciences* 141, pp. 218-233.
- CIS WFD, 2005, 'Substance EQS data sheets', Common Implementation Strategy (CIS) for the Water Framework Directive (<https://circabc.europa.eu/w/browse/8d2c7c28-358e-4ddf-8a0e-149f6667c19f>) accessed 18 October 2018.
- Council of the European Union, 2009, Combination effects of chemicals, 17820/09 (<http://register.consilium.europa.eu/doc/srv?!=EN&f=ST%2017820%202009%20INIT>) accessed 17 October 2018.
- DAFM, 2013, National action plan for the sustainable use of pesticides, Department of Agriculture, Food and the Marine, Ireland (https://www.teagasc.ie/media/website/animals/dairy/NationalActionPlan_SustainableUsePesticides.pdf) accessed 15 November 2018.
- DEFRA, 2015, *Review of socioeconomic impacts of pharmaceuticals in the water environment*, Technical report WT1544, Department for Environment, Food and Rural Affairs, London, UK.
- Doppler, T., et al., 2017, 'Hohe PSM-Belastung in Schweizer Bächen', *Aqua & Gas* 4, pp. 46-56.
- Earnshaw, M., et al., 2013, 'Estimating European historical production, consumption and atmospheric

- emissions of decabromodiphenyl ether', *Science of the Total Environment* 447, pp. 133-142.
- EC, 1973, Declaration of the Council of the European Communities and of the representatives of the Governments of the Member States meeting in the Council of 22 November 1973 on the programme of action of the European Communities on the environment (OJ C 112/1, 20.12.1973) (<https://eur-lex.europa.eu/legal-content/EN/TXT/PDF/?uri=OJ:C:1973:112:FULL&from=EN>) accessed 3 September 2018.
- EC, 2011a, *Polycyclic aromatic hydrocarbons (PAHs) factsheet*, JRC Technical Notes, JRC 66955-2011, Joint Research Centre, European Commission.
- EC, 2011b, *Guidance Document No. 27: deriving environmental quality standards*, European Commission (http://ec.europa.eu/environment/water/water-framework/facts_figures/guidance_docs_en.htm) accessed 3 September 2018.
- EC, 2012, *Guidance Document No. 28: Technical guidance on the preparation of an inventory of emissions, discharges and losses of priority and priority hazardous substances*, European Commission.
- EC, 2015, Communication from the Commission to the European Parliament, the Council, the European Economic and Social Committee and the Committee of the Regions 'Closing the loop — an EU action plan for the Circular Economy', European Commission COM(2015) 614 final (https://eur-lex.europa.eu/resource.html?uri=cellar:8a8ef5e8-99a0-11e5-b3b7-01aa75ed71a1.0012.02/DOC_1&format=PDF) accessed 3 September 2018.
- EC, 2018a, *EU Pesticides Database* (<http://ec.europa.eu/food/plant/pesticides/eu-pesticides-database/public/?event=activesubstance.selection&language=EN>) accessed 15 November 2018.
- EC, 2018b, *Neonicotinoids*, (https://ec.europa.eu/food/plant/pesticides/approval_active_substances/approval_renewal/neonicotinoids_en) accessed 15 November 2018.
- EEA, 2001, *Late lessons from early warnings*, EEA Report No 22/2001, European Environment Agency.
- EEA, 2011, *Hazardous substances in Europe's fresh and marine waters*, EEA Technical Report No 8/2011, European Environment Agency.
- EEA, 2012, *European waters — assessment of status and pressures*, EEA Report No 8/2012, European Environment Agency.
- EEA, 2013, *Late lessons from early warnings II*, EEA Report No 1/2013, European Environment Agency.
- EEA, 2015, 'Waterbase_2015_v1_WISE1' (<https://www.eea.europa.eu/data-and-maps/data/waterbase-emissions-5>) accessed 11 October 2016.
- EEA, 2017a, 'Water Framework Directive reporting resources', http://cdr.eionet.europa.eu/help/WFD/WFD_521_2016 accessed 17 August 2017.
- EEA, 2017b, 'E-PRTR database version 11' (<https://www.eea.europa.eu/data-and-maps/data/member-states-reporting-art-7-under-the-european-pollutant-release-and-transfer-register-e-prtr-regulation-14>) accessed 18 August 2017.
- EEA, 2018a, *European waters — assessment of status and pressures 2018*, EEA Report No 7/2018, European Environment Agency.
- EEA, 2018b, *EEA 2018 water assessment* <https://www.eea.europa.eu/themes/water/european-waters/water-quality-and-water-assessment/water-assessments> accessed 15 November 2018.
- EEA, 2018c, Industrial pollution country profiles (<https://www.eea.europa.eu/themes/industry/industrial-pollution/>) accessed 15 November 2018.
- EEA, 2018d, *The European Pollutant Release and Transfer Register (E-PRTR), Member States reporting under Article 7 of Regulation (EC) No 166/2006* (<https://www.eea.europa.eu/data-and-maps/data/member-states-reporting-art-7-under-the-european-pollutant-release-and-transfer-register-e-prtr-regulation-21>) accessed 15 November 2018.
- EEA, 2018e, *Mercury in Europe's environment*, EEA Report No 11/2018, European Environment Agency.
- EEA, 2018f, 'Air pollutant emissions dataviewer (LRTAP Convention)' (<https://www.eea.europa.eu/data-and-maps/dashboards/air-pollutant-emissions-data-viewer-1>) accessed 5 September 2018.
- EEA, 2018g, *Chemicals for a sustainable future*, (<https://www.eea.europa.eu/about-us/governance/scientific-committee/reports/chemicals-for-a-sustainable-future>) accessed 15 November 2018.
- Egeback, A-L, et al., 2012, 'Decabromodiphenyl ethane and decabromodiphenyl ether in Swedish background air', *Chemosphere* 86(3), pp. 264-269.
- EMEP, 2018, 'Co-operative programme for monitoring and evaluation of the long-range transmissions of

air pollutants in Europe' (<http://www.msceast.org/index.php/pollution-assessment/emep-domain-menu>) accessed 15 November 2018.

Environment Agency, 2008, *Long-term exposure to environmentally relevant concentrations of ethinyloestradiol affects sexual differentiation and development in roach, Rutilus rutilus*, Science Report SC030299/SR2, Environment Agency, Bristol, UK.

Environment Agency, 2013, *Nonylphenol ethoxylates in imported textiles* (https://assets.publishing.service.gov.uk/government/uploads/system/uploads/attachment_data/file/296853/13_04_29_Rpt_NPE_textiles_summary_report_LIT_7721__5b9cd4.pdf) accessed 20 August 2018.

EPA, 2017, *Technical fact sheet — polybrominated diphenyl ethers (PBDEs)*, EPA 505-F-17-015, United States Environmental Protection Agency.

EPRS, 2015, *The precautionary principle*, European Parliamentary Research Service, PE 573.876 ([http://www.europarl.europa.eu/RegData/etudes/IDAN/2015/573876/EPRS_IDA\(2015\)573876_EN.pdf](http://www.europarl.europa.eu/RegData/etudes/IDAN/2015/573876/EPRS_IDA(2015)573876_EN.pdf)) accessed 15 November 2018.

Escher, et al., 2014, 'Benchmarking organic micropollutants in wastewater, recycled water and drinking water with in vitro bioassays', *Environmental Science & Technology* 48(3), pp. 1940-1956.

ETC-ICM, 2015, *Hazardous substances in European Waters — analysis of the data on hazardous substances in groundwater, rivers, transitional, coastal and marine waters reported to the European Environment Agency from 2002-2011*, ETC-ICM Technical Report No 3/2015 (http://icm.eionet.europa.eu/ETC_Reports/HazardousSubstancesInWater_2015) accessed 3 September 2018.

ETC-ICM, 2017, *Emissions of pollutants to Europe's waters — sources, pathways and trends*, ETC-ICM Technical Report No 3/2017 (http://icm.eionet.europa.eu/ETC_Reports/EmissionsOfPollutantsToEuropeanWaters_SourcesPathwaysAndTrends) accessed 3 September 2018.

EU, 1976, Council Directive 76/464/EEC of 4 May 1976 on pollution caused by certain dangerous substances discharged into the aquatic environment of the Community (OJ L 129, 18.5.1976, p.23).

EU, 1982, Council Directive 96/82/EC of 9 December 1996 on the control of major-accident hazards involving dangerous substances (OJ L 10, 14.1.1997, p. 13), most recently amended by Regulation (EC) No 1137/2008

of the European Parliament and of the Council of 22 October 2008 adapting a number of instruments subject to the procedure laid down in Article 251 of the Treaty to Council Decision 1999/468/EC, with regard to the regulatory procedure with scrutiny — Adaptation to the regulatory procedure with scrutiny — Part One (OJ L 311, 21.11.2008, p. 1, 17) (the Directive was repealed on 1 July 2015 and replaced by Directive 2012/18/EU of the European Parliament and of the Council of 4 July 2012 on the control of major-accident hazards involving dangerous substances, amending and subsequently repealing Council Directive 96/82/EC (OJ L 197, 24.7.2012, p. 1)).

EU, 1986, Council Directive 86/278/EEC of 12 June 1986 on the protection of the environment, and in particular of the soil, when sewage sludge is used in agriculture (OJ L 181, 4.7.1986, p. 6-12).

EU, 1989, Council Directive 89/106/EC of 21 December 1988 on the approximation of laws, regulations and administrative provisions of the Member States relating to construction products (OJ L 40, 11.2.1989, p. 12), most recently amended by Regulation (EU) No 305/2011 of the European Parliament and of the Council of 9 March 2011 laying down harmonised conditions for the marketing of construction products and repealing Council Directive 89/106/EEC (OJ L 88, 4.4.2011, p. 5-43).

EU, 1991a, Council Directive 91/271/EEC of 21 May 1991 concerning urban waste-water treatment (OJ L 135, 30.5.1991, p. 40), most recently amended by Regulation (EC) No 1137/2008 of the European Parliament and of the Council of 22 October 2008 adapting a number of instruments subject to the procedure laid down in Article 251 of the Treaty to Council Decision 1999/468/EC, with regard to the regulatory procedure with scrutiny — Adaptation to the regulatory procedure with scrutiny — Part One (OJ L 311, 21.11.2008, p. 1, 14).

EU, 1991b, Council Directive 91/676/EEC of 12 December 1991 concerning the protection of waters against pollution caused by nitrates from agricultural sources (OJ L 375, 31.12.1991, p. 1), most recently amended by Regulation (EC) No 1137/2008 of the European Parliament and of the Council of 22 October 2008 adapting a number of instruments subject to the procedure laid down in Article 251 of the Treaty to Council Decision 1999/468/EC, with regard to the regulatory procedure with scrutiny — Adaptation to the regulatory procedure with scrutiny — Part One (OJ L 311, 21.11.2008, p. 1, 15).

EU, 1998, Council Directive 98/83/EC of 3 November 1998 on the quality of water intended for human

- consumption (OJ L 330, 5.12.1998, p. 32), most recently amended by Annex 2.2 to Regulation (EC) 596/2009 of the European Parliament and of the Council of 18 June 2009 adapting a number of instruments subject to the procedure referred to in Article 251 of the Treaty to Council Decision 1999/468/EC with regard to the regulatory procedure with scrutiny — Adaptation to the regulatory procedure with scrutiny — Part Four (OJ L 188, 18.7.2009, p. 14) (formerly Directive 76/160/EEC).
- EU, 2000, Directive 2000/60/EC of the European Parliament and of the Council of 23 October 2000 establishing a framework for Community action in the field of water policy (OJ L 327, 22.12.2000, p.1).
- EU, 2001, Directive 2001/42/EC of the European Parliament and of the Council of 27 June 2001 on the assessment of the effects of certain plans and programmes on the environment (OJ L 197, 21.7.2001, p. 30).
- EU, 2003, Directive 2003/11/EC of the European Parliament and of the Council of 6 February 2003 amending for the 24th time Council Directive 76/769/EEC relating to restrictions on the marketing and use of certain dangerous substances and preparations (pentabromodiphenyl ether, octabromodiphenyl ether) (OJ L 42, 15.2.2003).
- EU, 2004, Regulation (EC) No 726/2004 of the European Parliament and of the Council of 31 March 2004 laying down Community procedures for the authorisation and supervision of medicinal products for human and veterinary use and establishing a European Medicines Agency (OJ L 136, 30.4.2004, p. 1-33).
- EU, 2006a, Directive 2006/11/EC of the European Parliament and of the Council of 4 March 2006 on pollution caused by certain dangerous substances discharged into the aquatic environment of the Community (OJ L 64, 4.3.2006, p. 52) (formerly Directive 76/464/EEC).
- EU, 2006b, Directive 2006/118/EC of the European Parliament and of the Council of 12 December 2006 on the protection of groundwater against pollution and deterioration (OJ L 372, 27.12.2006, p. 19).
- EU, 2006c, Regulation (EC) No 166/2006 of the European Parliament and of the Council of 18 January 2006 concerning the establishment of a European Pollutant Release and Transfer Register and amending Council Directives 91/689/EEC and 96/61/EEC (OJ L 33, 4.2.2006, p. 1).
- EU, 2007, Regulation (EC) No 1907/2006 of the European Parliament and of the Council of 18 December 2006 concerning the Registration, Evaluation, Authorisation and Restriction of Chemicals (REACH), establishing a European Chemicals Agency, amending Directive 1999/45/EC and repealing Council Regulation (EEC) No 793/93 and Commission Regulation (EC) No 1488/94 as well as Council Directive 76/769/EEC and Commission Directives 91/155/EEC, 93/67/EEC, 93/105/EC and 2000/21/EC (OJ L 396, 30.12.2006, p. 1).
- EU, 2008a, Directive 2008/105/EC of the European Parliament and of the Council of 16 December 2008 on environmental quality standards in the field of water policy, amending and subsequently repealing Council Directives 82/176/EEC, 83/513/EEC, 84/156/EEC, 84/491/EEC and 86/280/EEC and amending Directive 2000/60/EC of the European Parliament and of the Council (OJ L 348, 24.12.2008, p. 84), amended by Directive 2013/39/EU of the European Parliament and of the Council of 12 August 2013 amending Directives 2000/60/EC and 2008/105/EC as regards priority substances in the field of water policy (OJ L 226, 24.8.2013, pp. 1, 6).
- EU, 2008b, Directive 2008/56/EC of the European Parliament and of the Council of 17 June 2008 establishing a framework for Community action in the field of marine environmental policy (OJ L 164, 25.6.2008, p. 19).
- EU, 2008c, Regulation (EC) No 1272/2008 of the European Parliament and of the Council of 16 December 2008 on classification, labelling and packaging of substances and mixtures, amending and repealing Directives 67/548/EEC and 1999/45/EC, and amending Regulation (EC) No 1907/2006 (OJ L 353, 31.12.2008, p. 1).
- EU, 2009a, Regulation (EC) No 1107/2009 of the European Parliament and of the Council of 21 October 2009 concerning the placing of plant protection products on the market and repealing Council Directives 79/117/EEC and 91/414/EEC (OJ L 309, 24.11.2009, p. 1).
- EU, 2009b, Directive 2009/128/EC of the European Parliament and of the Council of 21 October 2009 establishing a framework for Community action to achieve the sustainable use of pesticides (OJ L 309, 24.11.2009, p. 71).
- EU, 2010, Directive 2010/75/EU of the European Parliament and of the Council of 24 November 2010 on industrial emissions (integrated pollution prevention and control) (OJ L 334, 17.12.2010, p. 17).

- EU, 2011, Directive 2011/92/EU of the European Parliament and of the Council of 13 December 2011 on the assessment of the effects of certain public and private projects on the environment (OJ L 26, 28.1.2012, p. 1).
- EU, 2012a, Regulation (EU) No 528/2012 of 22 May 2012 concerning the making available on the market and use of biocidal products (OJ L 167, 27.6.2012, p. 1).
- EU, 2012b, Commission Regulation (EU) No 252/2012 of 21 March 2012 laying down methods of sampling and analysis for the official control of levels of dioxins, dioxin-like PCBs and non-dioxin-like PCBs in certain foodstuffs and repealing Regulation (EC) 1883/2006 (OJ L 84, 23.3.2012, p. 1).
- EU, 2013a, Directive 2013/39/EU of the European Parliament and of the Council of 12 August 2013 amending Directives 2000/60/EC and 2008/105/EC as regards priority substances in the field of water policy (OJ L 226, 24.8.2013, pp. 1-17).
- EU, 2013b, Decision No 1386/2013/EU of the European Parliament and of the Council of 20 November 2013 on a General Union Environment Action Programme to 2020 'Living well, within the limits of our planet', Annex A, paragraph 54e (OJ L 354, 28.12.2013, pp. 171-200).
- EU, 2016, Commission Implementing Regulation (EU) 2016/872 of 1 June 2016 concerning the non-renewal of approval of the active substance isoproturon, in accordance with Regulation (EC) No 1107/2009 of the European Parliament and of the Council concerning the placing of plant protection products on the market, and amending Commission Implementing Regulation (EU) No 540/2011 (OJ L 145, 2.6.2016, p. 7, 9).
- Eurostat, 2018, 'Agri-environmental indicator — consumption of pesticides' (https://ec.europa.eu/eurostat/statistics-explained/index.php?title=Agri-environmental_indicator_-_consumption_of_pesticides) accessed 5 September 2018.
- FGG Weser, 2016, *Bewirtschaftungsplan 2015 bis 2021 für die Flussgebietseinheit Weser gemäß §83 WHG*, Flussgebietsgemeinschaft Weser (accessed 3 September 2018).
- Fliedner, A., et al., 2016, 'Current levels and trends of selected EU Water Framework Directive priority substances in freshwater fish from the German environmental specimen bank', *Environmental Pollution* 216, pp. 866-876.
- Gardner, M., et al., 2012, 'The significance of hazardous chemicals in wastewater treatment works effluents', *Science of the Total Environment* 437, pp. 363-372.
- Gardner, M., et al., 2013, 'Performance of UK wastewater treatment works with respect to trace contaminants', *Science of the Total Environment* 456-457, pp. 359-369.
- Gardner, M., et al., 2014, *Chemical Investigations Programme: Volume 1 — Main Report*, United Kingdom Water Industry Research Report No 13/EQ/01/6, London.
- Grinten, E. et al., 2016, *Milieuafwegingen in de genesmiddelvevoorziening RIVM Briefrapport 2016-0207*, Rijksinstituut voor Volksgezondheid en Milieu, Netherlands.
- Gustavsson, M., et al., 2017, 'Pesticide mixtures in Swedish streams: environmental risk, contribution of individual compounds and consequences of single-substance oriented risk mitigation', *Science of the Total Environment* 598, pp. 973-983.
- ICPDR, 2018, <https://www.icpdr.org/main> (accessed 28 August 2018).
- ICPER, 2018, <https://www.ikse-mkol.org/en/ikse/fokus-2015> (accessed 28 August 2018).
- IKSR, 2018, <https://www.iksr.org/en/international-cooperation/legal-basis/convention> (accessed 28 August 2018).
- Johnson, A. C., et al., 2017, 'An alternative approach to risk rank chemicals on the threat they pose to the aquatic environment', *Science of the Total Environment* 599-600, pp. 1372-1381.
- JRC, 2016, 'Second review of the priority substances list under the Water Framework Directive: monitoring-based exercise' (unpublished), Joint Research Centre, Ispra, Italy.
- Kienle, C., et al., 2015, *Methoden zur Beurteilung der Wasserqualität anhand von ökotoxikologischen Biotests*, EAWAG, Switzerland.
- Knillmann, S., et al., 2018, 'Indication of pesticide effects and recolonization in streams', *Science of the Total Environment* 630, pp. 1619-1627.
- Kortenkamp, A., et al., 2009, State of the art report on mixture toxicity, University of London (http://ec.europa.eu/environment/chemicals/effects/pdf/report_mixture_toxicity.pdf) accessed 17 October 2018.

- Kunz, P. Y., et al., 2017, 'Effect-based tools for monitoring estrogenic mixtures: evaluation of five in vitro bioassays', *Water Research* 110, pp. 378-388.
- Langner, M., et al., 2017, 'Hohe ökotoxikologische Risiken in Bächen', *Aqua & Gas* 4, pp. 58-68.
- Länsstyrelsen Kalmar län, 2016, 'Förvaltningsplan 2016-2021 för Södra Östersjöns vattendistrikt. Del 2, Vattenförvaltning 2009-2015 — Resultat och samverkan'.
- Leusch, F. D. L., et al., 2018, 'Analysis of endocrine activity in drinking water, surface water and treated wastewater from six countries', *Water Research* 139, pp. 10-18.
- Lewis, K. A., et al., 2016, 'An international database for pesticide risk assessments and management', *Human and Ecological Risk Assessment: An International Journal* 22(4), pp. 1050-1064.
- Liess, M., et al., 1999, 'Determination of insecticide contamination in agricultural headwater streams', *Water Research* 33(1), pp. 239-247.
- Liess, M., and Von der Ohe, P.C., 2005, 'Analysing effects of pesticides on invertebrate communities in streams', *Environmental Toxicology and Chemistry* 24(4), pp. 954-965.
- Loos, R., et al., 2009, 'EU-wide survey of polar organic persistent pollutants in European river waters', *Environmental Pollution* 157(2), pp. 561-568.
- Loos, R., et al., 2013, 'EU-wide monitoring survey on emerging polar organic contaminants in wastewater treatment plant effluents', *Water Research* 47, pp. 6475-6487.
- Lyons, B. P., et al., 2017, 'Determining good environmental status under the Marine Strategy Framework Directive: case study for descriptor 8 (chemical contaminants)', *Marine Environmental Research* 124, pp. 118-129.
- Malaj, E., et al., 2014, 'Organic chemicals jeopardize the health of freshwater ecosystems on the continental scale', *Proceedings of the National Academy of Sciences of the United States of America* 111(26), pp. 9549-9554.
- Mao, Z., et al., 2012, 'Occurrence and biodegradation of nonylphenol in the environment', *International Journal of Molecular Sciences* 13(1), pp. 491-505.
- Ministère de la Transition écologique et solidaire, 2016, *National plan against micropollutants 2016-2021 to preserve water quality and biodiversity*, <https://www.ecologique-solidaire.gouv.fr/sites/default/files/National%20plan%20against%20micropollutants%202016-2021%20to%20preserve%20water%20quality%20and%20biodiversity.pdf> accessed 15 November 2018.
- Moschet, C., et al., 2014, 'How a complete pesticide screening changes the assessment of surface water quality', *Environmental Science & Technology* 48(10), pp. 5423-5432.
- MSC-E, 2016, 'Pollution assessment' (<http://www.msceast.org/index.php/pollution-assessment/and-more>) accessed 15 November 2018.
- Napierska, D., et al., 2018, *Modes of action of the current priority substances list under the Water Framework Directive and other substances of interest*, Joint Research Centre, Italy.
- Neale, P. A., et al., 2017, 'Integrating chemical analysis and bioanalysis to evaluate the contribution of wastewater effluent on the micropollutant burden in small streams', *Science of the Total Environment* 576, pp. 785-795.
- North, K. D., 2004, 'Tracking polybrominated diphenyl ether releases in a wastewater treatment plant effluent, Palo Alto, California', *Environmental Science & Technology* 38(17), pp. 4484-4488.
- Pirrone, N., et al., 2010, 'Global mercury emissions to the atmosphere from anthropogenic and natural sources', *Atmospheric Chemistry and Physics* 10(13), pp. 5951-5964.
- Posthuma, L., et al., 2017, 'Prospective mixture risk assessment and management prioritizations for river catchments with diverse land uses', *Environmental Toxicology and Chemistry* 37(3), 715-728.
- Reemtsma, T., et al., 2016, 'Mind the gap: persistent and mobile organic compounds — water contaminants that slip through', *Environmental Science & Technology* 50(19), pp. 10308-10315.
- Ricklund, N., et al., 2010, 'Levels and potential sources of decabromodiphenyl ethane (DBDPE) and decabromodiphenyl ether (DecaBDE) in lake and marine sediments in Sweden', *Environmental Science & Technology* 44(6), pp. 1987-1991.
- Rico, A., et al., 2016, 'Relative influence of chemical and non-chemical stressors', *Science of the Total Environment* 571, pp. 1370-1382.

- Roovaart, J., et al., 2013a, *Diffuse water emissions in E-PRTR: project report*, Report No 1205118-000-ZWS-0016, Deltares, Netherlands.
- Roovaart, J., et al., 2013b, *Diffuse water emissions in E-PRTR: dissemination document*, Report No 1205118-000-ZWS-0018, Deltares, Netherlands.
- Roovaart, J., et al., 2017, *Emissions of pollutants to Europe's waters — sources, pathways and trends*, ETC-ICM Technical Report No 3/2017, Magdeburg.
- Schäfer, R. B., et al., 2016, 'Contribution of organic toxicants to multiple stress in river ecosystems', *Freshwater Biology* 61, pp. 2116-2128.
- Schulze, T., et al., 2017, 'Assessment of a novel device for onsite integrative large-volume solid phase extraction of water samples to enable a comprehensive chemical and effect-based analysis', *Science of the Total Environment* 581-582, pp. 350-358.
- Shardlow, M., 2017, 'Heavy neonicotinoid insecticide contamination damaging British rivers', Buglife (<https://www.buglife.org.uk/news-and-events/news/heavy-neonicotinoid-insecticide-contamination-damaging-british-rivers>) accessed 30 June 2018.
- UBA, 2011, *Factsheet for RBSP regulated in German Surface Water Ordinance*, German Environment Agency, Germany.
- UBA, 2016, *Factsheet for RBSP regulated in German Surface Water Ordinance*, German Environment Agency, Germany.
- UBA, 2017a, *Waters in Germany — Status and Assessment*, German Environment Agency, Dessau, Germany.
- UBA, 2017b, *Policy Paper — Recommendations from the multi-stakeholder dialogue on the trace substance strategy of the German Federal Government*, (http://www.bmu.de/fileadmin/Daten_BMU/Download_PDF/Binnengewasser/spurenstoffstrategie_policy_paper_en_bf.pdf) German Environment Agency, accessed 15 November 2018.
- UBA, 2018, *Recommendations for reducing micropollutants in waters*, German Environment Agency, Dessau, Germany.
- UNEP, 2017, *Frontiers 2017: emerging issues of environmental concern*, United Nations Environment Programme (<https://www.unenvironment.org/resources/frontiers-2017-emerging-issues-environmental-concern>) accessed 19 October 2018.
- UNEP/OCHA, 2000, *Spill of liquid and suspended waste at the Aurul S.A. retreatment plant in Baia Mare*, United Nations, Geneva.
- Vorkamp, K. and Sanderson, H., 2016, 'European Environmental Quality Standards (EQS) Variability Study — analysis of the variability between national EQS values across Europe for selected Water Framework Directive river basin-specific pollutants', in: Scientific Report No 198, Danish Centre for Environment and Energy.
- Wernersson, A-S., et al., 2014, *Technical report on aquatic effect-based monitoring tools*, European Union Technical Report 2014-077, Luxembourg.
- WHO, 2018, 'One Health' <http://www.who.int/features/qa/one-health/en>, accessed 19 October 2018.
- Zhang, B., et al., 2017, 'Emission inventory and environmental distribution of decabromodiphenyl ether in China', *Science of the Total Environment* 599-600, pp. 1073-1081.

Annex 1 Derivation of emissions data for the figures in Chapter 3

The emissions data for the priority substances were calculated as described below.

The data reported for the E-PRTR on industrial waste water (P10) and UWWTPs (P8) are included in Figures 3.2-3.14. The E-PRTR uses capacity thresholds (e.g. > 100 000 population equivalent (p.e.) for UWWTPs and pollutant thresholds that vary per pollutant).

The data source used was database version 11 (EEA, 2017b). To gain an indication of the possible trends over time, two years were considered: 2010 and 2015. Because data were not necessarily available for each year, the following selection process was applied. For 2010, data from 2010 were selected, then, if data from 2010 were not available, data from 2011 were selected and then, if data from 2011 were not available, data from 2009 were selected. If no data were reported for 2009-2011, no data were recorded for that substance by that country. Similarly, for 2015 data, 2015 was the preferred dataset, followed by 2014. If no data were reported for 2015 or 2014, no data were recorded for that country.

Data are included from the WISE-SoE emissions dataset. Industry (P10), UWWTPs (P8) and diffuse sources (other pathways) were used from the Waterbase_2015_v1_WISE1 database (EEA, 2015). Emissions data for 2010 were selected in similar way to the E-PRTR data (i.e. from 2009-2011 datasets). Data from 2014 were used as the latest available and 2013 data were used if 2014 data were not available.

WFD emissions data for 2010 are included for Member States that reported via the WFD input inventory (EEA, 2017a). In some cases, Member States used another year for reporting (sometimes 2009) or the average of a number of years (such as 2008/2009/2010). In that case, the closest year to 2010 or the reported average was used. Because the dataset contained a number of errors and inconsistent data, a

subset of this dataset is used for this report. Depending on the pollutant, only 3-13 Member States reported data for industry and UWWTPs. Diffuse sources were reported by only a few Member States. Most Member States reported only a subset of river basin districts in the country. Following the recommendations of EU Technical Guidance No 28 (EC, 2012), some (but not all) countries reported only emissions for substances identified as relevant for the river basin. This means that, if a substance is 'not relevant' for a river basin, E-PRTR reporting and WFD reporting might not be comparable.

In short, the WFD dataset contains a number of double counting, inconsistencies and incorrect values, which makes it hard to interpret the data, including:

- Different years are used by Member States for the different reporting streams and reported data on the same sources appear to be inconsistent with each other.
- Different definitions and incomplete reporting of diffuse sources by the Member States.

Diffuse loads to surface water were estimated for 2010 (Estimated diffuse 2010) by Roovaart et al. (2013a, b) for all EU Member States. The estimations are limited to a selection of key sources and pollutants: atmospheric deposition (metals), inland navigation (anthracene, fluoranthene), road transport (metals), un-connected households and UWWTPs below 100 000 population equivalents (metals and PAHs). Per pollutant, the load for these sectors is estimated, so it does not represent the total load of all existing diffuse sources.

In this context, numbers in the emissions tables and figures should be understood to be of low confidence. The loads given in the tables from different data sources cannot be summed, as there may be double counting.

Table A1.1 Reported emissions and deposition data for mercury (tonnes/year) with the number of EU Member States reporting in brackets

Emissions into water	Mercury	
	2010	2014/2015
Industry		
E-PRTR	2.6 (22 ^b)	1.5 (23 ^b)
WISE	4.5 (22 ^b)	2 (23 ^b ; ^c)
WFD	3.4 (13)	
UWWTPs		
E-PRTR	1.7 (24 ^b)	2.1 (21 ^b)
WISE	2.0 (23)	4 (20 ^c)
WFD	4.1 (10)	
Diffuse sources		
WISE	1.18 (2)	1.14 (1)
WFD	0.7 (8)	
Estimated diffuse 2010 (^a)	11 (28)	

Notes: Numbers in the emissions tables and figures should be understood to be of low confidence. The loads given in the tables from different data sources cannot be summed, as there may be double counting.

(^a) Source: Roovaart et al., 2013b.

(^b) Including Norway.

(^c) Reported emissions to water in the WISE (2014/2015) show extreme loads from a single Member State, for both industry (85 tonnes by one Member State and 2 tonnes by the other 23 Member States reporting) and UWWTPs (1 309 tonnes by one Member State and 4 tonnes by the other 20 Member States reporting). These values were excluded from calculation.

Table A1.2 Reported emissions data for benzo(g,h,i)perylene, indeno(1,2,3-cd)-pyrene, fluoranthene and benzo(a)pyrene (tonnes/year) with the number of EU Member States reporting in brackets

Emissions into water	Benzo(g,h,i)perylene		Indeno(1,2,3-cd)-pyrene (^c)		Fluoranthene		Benzo(a)pyrene (^c)	
	2010	2014/2015	2010	2014/2015	2010	2014/2015	2010	2014/2015
Industry								
E-PRTR	0.1 (9 ^b)	0.2 (7 ^b)			7.3 (13 ^b)	1.2 (11 ^b)		
WISE	0.008 (4)	0.016 (3)	0.007 (3)	0.004 (2)	7.3 (14 ^b)	151 (13 ^b)	0.007 (3)	0.005 (2)
WFD	0.1 (4)		0.04 (5)		0.45 (7)		0.25 (7)	
UWWTPs								
E-PRTR	0.1 (7)	0.04 (4)			0.1 (11)	0.1 (10)		
WISE	0.001 (1)	0.048 (2)		0.102 (1)	0.1 (11)	120 (7)	0.001 (1)	0.084 (1)
WFD	0.31 (2)		0.24 (2)		4.4 (5)		0.29 (4)	
Diffuse sources								
WISE	0.22 (2)	0.21 (1)	0.23 (2)	0.17 (1)	0.9 (2)	0.33 (1)	0.25 (2)	0.2 (1)
WFD	0.08 (2)		0.07 (3)		0.88 (6)		0.21 (5)	
Estimated diffuse 2010 (^a)					0.97 (29 ^b)			

Notes: Numbers in the emissions tables and figures should be understood to be of low confidence. The loads given in the tables from different data sources cannot be summed, as there may be double counting.

(^a) Source: Roovaart et al., 2013b.

(^b) Including Norway.

(^c) Indeno(1,2,3-cd)-pyrene and benzo(a)pyrene are not included in the E-PRTR as single substances but as PAHs (EC, 2006b, Annex II).

Table A1.2 Reported emissions data for benzo(b)fluoranthene, benzo(k)fluoranthene and anthracene (tonnes/year) with the number of EU Member States reporting in brackets (cont.)

Emissions into water	Benzo(b)fluoranthene (°)		Benzo(k)fluoranthene (°)		Anthracene	
	2010	2014/2015	2010	2014/2015	2010	2014/2015
Industry						
E-PRTR					0.2 (6 ^b)	0.2 (7 ^b)
WISE	0.012 (4)	0.006 (2)	0.007 (3)	0.003 (2)	0.2 (9 ^b)	0.2 (4 ^b)
WFD	0.24 (5)		0.03 (5)		0.1 (6)	
UWWTPs						
E-PRTR					0.1 (7)	1.7 (4)
WISE	0.002 (1)	0.071 (1)	0.001 (1)	0.087 (1)	0.1 (9)	0.3 (6)
WFD	0.26 (2)		0.2 (2)		0.34 (7)	
Diffuse sources						
WISE	0.5 (2)	0.3 (1)	0.22 (2)	0.15 (1)	0.23 (2)	0.08 (1)
WFD	0.15 (3)		0.07 (3)		1.2 (7)	
Estimated diffuse 2010 (°)					0.23 (29b)	

Notes: Numbers in the emissions tables and figures should be understood to be of low confidence. The loads given in the tables from different data sources cannot be summed, as there may be double counting.

(°) Source: Roovaart et al., 2013b.

(^b) Including Norway.

(^c) Benzo(b)fluoranthene and benzo(k)fluoranthene are not included in the E-PRTR as single substances but as PAHs (EC, 2006b, Annex II).

Table A1.3 Reported emissions data for pBDEs (tonnes/year) with the number of EU Member States reporting in brackets

Emissions into water	pBDEs	
	2010	2014/2015
Industry		
E-PRTR	0.011 (2)	0.003 (2)
WISE		
WFD	0.15 (3)	
UWWTPs		
E-PRTR	0.03 (3)	
WISE	0.008 (1)	
WFD	0.004 (3)	
Diffuse sources		
WISE	0.01 (1)	
WFD	0.02 (4)	

Note: Numbers in the emissions tables and figures should be understood to be of low confidence. The loads given in the tables from different data sources cannot be summed, as there may be double counting.

Table A1.4 Reported emissions data for DEHP (tonnes/year) with the number of EU Member States reporting in brackets

Emissions into water	DEHP	
	2010	2014/2015
Industry		
E-PRTR	0.5 (12)	0.4 (12 ^a)
WISE	3.7 (14)	2.5 (13)
WFD	11 (6)	
UWWTPs		
E-PRTR	27 (17 ^a)	17 (16 ^a)
WISE	29 (17 ^a)	28 (17 ^a)
WFD	17 (8)	
Diffuse sources		
WISE	0.11 (2)	
WFD	27 (5)	

Notes: Numbers in the emissions tables and figures should be understood to be of low confidence. The loads given in the tables from different data sources cannot be summed, as there may be double counting.

(^a) Including Norway.

Table A1.5 Reported emissions data for 4-nonylphenol (tonnes/year) with the number of EU Member States reporting in brackets

Emissions into water	4-nonylphenol	
	2010	2014/2015
Industry		
E-PRTR	2.9 (11)	4.5 (10 ^a)
WISE	3.5 (11)	7.3 (12 ^a)
WFD	1.3 (4)	
UWWTPs		
E-PRTR	35 (16 ^a)	23 (15 ^a)
WISE	24 (16 ^a)	22 (16 ^a)
WFD	17 (8)	
Diffuse sources		
WISE		
WFD	2.2 (5)	

Notes: Numbers in the emissions tables and figures should be understood to be of low confidence. The loads given in the tables from different data sources cannot be summed, as there may be double counting.

^(a) Including Norway.

Table A1.6 Reported emissions data for cadmium, nickel and lead (tonnes/year) with the number of EU Member States reporting in brackets

Emissions into water	Cadmium		Nickel		Lead	
	2010	2014/2015	2010	2014/2015	2010	2014/2015
Industry						
E-PRTR	7.2 (21 ^b)	8.7 (20 ^b)	120 (24 ^b)	96 (26 ^b)	110 (26 ^b)	68 (22 ^b)
WISE	8.9 (24 ^b)	53 (23 ^b)	142 (26 ^b)	186 (26 ^b)	134 (26 ^b)	101 (27 ^b)
WFD	18 (13)		77 (13)		46 (13)	
UWWTPs						
E-PRTR	11 (21 ^b)	8.8 (22 ^b)	179 (24 ^b)	165 (24 ^b)	69 (22 ^b)	68 (24 ^b)
WISE	14 (22 ^b)	60 (25 ^b)	271 (25 ^b)	227 (25 ^b)	103 (22 ^b)	88 (26 ^b)
WFD	12(13)		121 (12)		51 (11)	
Diffuse sources						
WISE	2.02 (2)	0.76 (1)	62 (2)	7 (1)	52 (2)	31 (1)
WFD	2.1 (8)		116 (9)		77 (9)	
Estimated diffuse 2010 ^(a)	50 (28 ^b)		473 (28 ^b)		462 (28 ^b)	

Notes: Numbers in the emissions tables and figures should be understood to be of low confidence. The loads given in the tables from different data sources cannot be summed, as there may be double counting.

^(a) Source: Roovaart et al., 2013.

^(b) Including Norway.

Table A1.7 Reported emissions data for HCH (tonnes/year) with the number of EU Member States reporting in brackets

Emissions into water	HCH	
	2010	2014/2015
Industry		
E-PRTR	0.4 (6)	0.03 (2)
WISE		
WFD	0.001 (5)	
UWWTPs		
E-PRTR	0.1 (4)	0.01 (3)
WISE	0.02 (1)	
WFD	1.2 (4)	
Diffuse sources		
WISE	0.02 (1)	
WFD	0.06 (3)	

Note: Numbers in the emissions tables and figures should be understood to be of low confidence. The loads given in the tables from different data sources cannot be summed, as there may be double counting.

Table A1.8 Reported emissions data for isoproturon (tonnes/year) with the number of EU Member States reporting in brackets

Emissions into water	Isoproturon	
	2010	2014/2015
Industry		
E-PRTR	0.08 (6 ^a)	0.04 (2)
WISE	0.08 (2)	0.0002 (1)
WFD	0.03 (5)	
UWWTPs		
E-PRTR	0.2 (8)	0.1 (6)
WISE	0.006 (1)	0.00001 (1)
WFD	0.49 (3)	
Diffuse sources		
WISE	6.8 (2)	0.1 (1)
WFD	13 (5)	

Notes: Numbers in the emissions tables and figures should be understood to be of low confidence. The loads given in the tables from different data sources cannot be summed, as there may be double counting.

(^a) Including Norway.

Table A1.9 Reported emissions data for tributyltin-cation (tonnes/year) with the number of EU Member States reporting in brackets

Emissions into water	Tributyltin-cation	
	2010	2014/2015
Industry		
E-PRTR	40 (5)	0.004 (2)
WISE		0.0005 (2)
WFD	0.01 (4)	
UWWTPs		
E-PRTR	0.1 (7)	0.01 (3)
WISE		0.002 (2)
WFD	0.02 (3)	
Diffuse sources		
WISE		
WFD	0.02 (2)	

Notes: Numbers in the emissions tables and figures should be understood to be of low confidence. The loads given in the tables from different data sources cannot be summed, as there may be double counting.

(^a) Including Norway.

European Environment Agency

Chemicals in European water — Knowledge developments

2018 — 76 pp. — 21 x 29.7 cm

ISBN 978-92-9480-006-0

doi: 10.2800/265080

HOW TO OBTAIN EU PUBLICATIONS

Free publications:

- one copy:
via EU Bookshop (<http://bookshop.europa.eu>);
- more than one copy or posters/maps:
from the European Union's representations (http://ec.europa.eu/represent_en.htm);
from the delegations in non-EU countries (http://eeas.europa.eu/delegations/index_en.htm);
by contacting the Europe Direct service (http://europa.eu/eurodirect/index_en.htm) or calling 00 800 6 7 8 9 10 11 (freephone number from anywhere in the EU) (*).

(* The information given is free, as are most calls (though some operators, phone boxes or hotels may charge you).

Priced publications:

- via EU Bookshop (<http://bookshop.europa.eu>).

European Environment Agency
Kongens Nytorv 6
1050 Copenhagen K
Denmark

Tel.: +45 33 36 71 00
Web: eea.europa.eu
Enquiries: eea.europa.eu/enquiries



Publications Office

